



# **DEEP SEA ELECTRONICS**

## **DSEE400 Operator Manual**

**Document Number: 057-252**

Author: Ashley Senior



Deep Sea Electronics Ltd.  
Highfield House  
Hunmanby  
North Yorkshire  
YO14 0PH  
ENGLAND

Sales Tel: +44 (0) 1723 890099  
E-mail: sales@deepseaelectronics.com  
Website: www.deepseaelectronics.com

### DSEE400 Operator Manual

© Deep Sea Electronics Ltd.

All rights reserved. No part of this publication may be reproduced in any material form (including photocopying or storing in any medium by electronic means or other) without the written permission of the copyright holder except in accordance with the provisions of the Copyright, Designs and Patents Act 1988.

Applications for the copyright holder's written permission to reproduce any part of this publication must be addressed to Deep Sea Electronics Ltd. at the address above.

The DSE logo is a UK registered trademarks of Deep Sea Electronics Ltd.

Any reference to trademarked product names used within this publication is owned by their respective companies.

Deep Sea Electronics Ltd reserves the right to change the contents of this document without prior notice.

### Amendments Since Last Publication

Amd. No.	Comments
1	Initial Release
1.1	Updated panel cutout dimensions (inches). Corrected terminal descriptions (A15 to A18)
2	Rebranding to DSE Control
3	Updated Front Panel Configuration parameters Added Speed Control Editor Added Manual Speed Control Added Manual Run Time
4	Amended Connector A and Connector C Socket Terminal information Added to list of relevant Training Guides
5	Updated PWM(i) to 500 Hz max Added FPE items for Clutch Control
6	Added Maintain value and accompanying settings. Increased maintenance alarms
7	Update for v6 (hardware v2) including new PLC
8	Updated Adjustable Parameters and Config Suite images for v7.
9	Added charger section.

## TABLE OF CONTENTS

Section	Page
<b>1 INTRODUCTION.....</b>	<b>6</b>
1.1 CLARIFICATION OF NOTATION.....	7
1.2 GLOSSARY OF TERMS.....	7
1.3 BIBLIOGRAPHY.....	9
1.3.1 INSTALLATION INSTRUCTIONS.....	9
1.3.2 TRAINING GUIDES.....	9
1.3.3 MANUALS.....	10
<b>2 SPECIFICATION.....</b>	<b>11</b>
2.1 OPERATING TEMPERATURE.....	11
2.1.1 SCREEN HEATER OPERATION.....	11
2.2 REQUIREMENTS FOR UL.....	11
2.3 TERMINAL SPECIFICATION.....	11
2.4 POWER SUPPLY REQUIREMENTS.....	12
2.4.1 MODULE SUPPLY.....	12
2.4.1.1 MODULE SUPPLY INSTRUMENTATION DISPLAY.....	12
2.4.2 PWMI SUPPLY.....	12
2.5 INPUTS.....	13
2.5.1 DIGITAL INPUTS.....	13
2.5.1.1 POSITIVE SWITCHING CONFIGURATION.....	13
2.5.1.2 NEGATIVE SWITCHING CONFIGURATION.....	13
2.5.2 EMERGENCY STOP.....	13
2.5.3 ANALOGUE INPUTS.....	14
2.5.3.1 ANALOGUE INPUT A.....	14
2.5.3.2 ANALOGUE INPUT B TO G.....	15
2.5.4 CHARGE FAIL INPUT.....	16
2.5.5 MAGNETIC PICKUP.....	16
2.6 OUTPUTS.....	17
2.6.1 DC OUTPUTS A & B (FUEL & START).....	17
2.6.2 CONFIGURABLE DC OUTPUTS C & D.....	17
2.6.3 CONFIGURABLE PWMI OUTPUTS E & F.....	17
2.6.3.1 CONFIGURED AS DC OUTPUTS.....	17
2.6.3.2 CONFIGURED AS PWMI OUTPUTS.....	17
2.6.4 GOVERNOR OUTPUT.....	17
2.6.4.1 0 V TO 10 V CONFIGURATION.....	17
2.6.4.2 0 MA TO 20 MA CONFIGURATION.....	18
2.7 COMMUNICATION PORTS.....	18
2.8 COMMUNICATION PORT USAGE.....	19
2.8.1 USB SLAVE PORT (PC CONFIGURATION).....	19
2.8.2 RS485 PORT.....	20
2.8.2.1 CABLE SPECIFICATION.....	20
2.8.2.2 RECOMMENDED PC RS485 SERIAL PORT ADD-ONS.....	21
2.8.3 ECU PORT (J1939).....	22
2.9 ADDING AN EXTERNAL SOUNDER.....	23
2.10 ACCUMULATED INSTRUMENTATION.....	23
2.11 DIMENSIONS AND MOUNTING.....	24
2.11.1 DIMENSIONS.....	24
2.11.2 PANEL CUTOUT.....	24
2.11.3 MOUNTING HOLE SPACING.....	24
2.11.4 MOUNTING DIAMETER.....	24
2.11.5 WEIGHT.....	24
2.11.6 SILICON SEALING GASKET.....	25
2.12 APPLICABLE STANDARDS.....	26
2.12.1 ENCLOSURE CLASSIFICATIONS.....	27
2.12.1.1 IP CLASSIFICATIONS.....	27
2.12.1.2 NEMA CLASSIFICATIONS.....	27

<b>3</b>	<b>INSTALLATION</b>	<b>28</b>
3.1	USER CONNECTIONS	28
3.2	CONNECTION DESCRIPTIONS	28
3.2.1	CONNECTOR A	29
3.2.2	CONNECTOR C	30
3.2.3	USB SLAVE (PC CONFIGURATION) CONNECTOR	31
3.3	TYPICAL WIRING DIAGRAM	32
3.4	EARTH SYSTEMS	34
3.4.1	NEGATIVE EARTH	34
3.4.2	POSITIVE EARTH	34
3.4.3	FLOATING EARTH	34
<b>4</b>	<b>DESCRIPTION OF CONTROLS</b>	<b>35</b>
4.1	CONTROL PUSH BUTTONS	36
4.2	VIEWING THE INSTRUMENT PAGES	38
4.2.1	STATUS	39
4.2.1.1	ENGINE LOCKED OUT	39
4.2.2	ENGINE	40
4.2.2.1	DPF REGENERATION LAMPS	41
4.2.2.2	MAINTAIN VALUE CONTROL	42
4.2.3	ALARMS	43
4.2.3.1	ECU ALARMS (CAN FAULT CODES / DTC)	43
4.2.4	EVENT LOG	44
4.2.5	SERIAL PORT	45
4.2.6	ABOUT	46
4.2.7	PLC INSTRUMENTS	47
4.2.8	CHARGER	49
<b>5</b>	<b>OPERATION</b>	<b>51</b>
5.1	QUICKSTART GUIDE	51
5.1.1	STARTING THE ENGINE	51
5.1.2	STOPPING THE ENGINE	52
5.2	STOP/RESET MODE	53
5.2.1	ECU OVERRIDE	54
5.3	AUTOMATIC MODE	55
5.3.1	WAITING IN AUTO MODE	55
5.3.2	STARTING SEQUENCE	55
5.3.3	ENGINE RUNNING	56
5.3.4	STOPPING SEQUENCE	56
5.4	MANUAL/START MODE	57
5.4.1	STARTING SEQUENCE	57
5.4.2	ENGINE RUNNING	58
5.4.3	MANUAL SPEED CONTROL	58
5.4.4	MANUAL RUN TIME	58
5.4.5	STOPPING SEQUENCE	58
5.5	SCHEDULER	59
5.5.1	STOP MODE	59
5.5.2	AUTO MODE	59
5.5.3	MANUAL/START MODE	59
<b>6</b>	<b>PROTECTIONS</b>	<b>60</b>
6.1	ALARMS	60
6.1.1	PROTECTIONS DISABLED	61
6.1.1.1	INDICATION AND WARNING ALARMS	61
6.1.1.2	SHUTDOWN AND CONTROLLED SHUTDOWN ALARMS	62
6.1.2	ECU ALARMS (CAN FAULT CODES / DTC)	62
6.2	INDICATIONS	63
6.3	WARNING ALARMS	64
6.4	CONTROLLED SHUTDOWN ALARMS	67
6.5	SHUTDOWN ALARMS	70
6.6	MAINTENANCE ALARMS	73

<b>7</b>	<b>FRONT PANEL CONFIGURATION.....</b>	<b>74</b>
7.1	ACCESSING THE FRONT PANEL CONFIGURATION EDITOR .....	75
7.1.1	ENTERING PIN .....	75
7.1.2	EDITING A PARAMETER .....	76
7.1.3	EDITING A PLC INSTRUMENT PARAMETER .....	76
7.1.4	EXITING THE MAIN CONFIGURATION EDITOR .....	77
7.1.5	ADJUSTABLE PARAMETERS .....	78
7.1.6	EDITING A PARAMETER .....	81
<b>8</b>	<b>COMMISIONING.....</b>	<b>82</b>
<b>9</b>	<b>FAULT FINDING.....</b>	<b>83</b>
9.1	STARTING .....	83
9.2	LOADING .....	83
9.3	ALARMS .....	84
9.4	COMMUNICATIONS .....	84
9.5	MISCELLANEOUS.....	84
<b>10</b>	<b>MAINTENANCE, SPARES, REPAIR AND SERVICING .....</b>	<b>85</b>
10.1	CONNECTOR A FROM DSE .....	85
10.2	CONNECTOR C FROM DSE .....	85
10.3	WIRING HARNESS WITH CONNECTOR A & C FROM DSE .....	85
10.4	REPLACEMENT USB SEALING BUNG FROM DSE .....	86
10.5	REPLACEMENT PANELSEALING GASKET FROM DSE .....	86
10.6	USB CONFIGURATION CABLE FROM DSE .....	86
<b>11</b>	<b>WARRANTY .....</b>	<b>87</b>
<b>12</b>	<b>DISPOSAL.....</b>	<b>87</b>
12.1	WEEE (WASTE ELECTRICAL AND ELECTRONIC EQUIPMENT) .....	87

## 1 INTRODUCTION

This document details the installation and operation requirements of the DSEE400 module, part of the DSEControl® range of products.

The manual forms part of the product and should be kept for the entire life of the product. If the product is passed or supplied to another party, ensure that this document is passed to them for reference purposes.

This is not a *controlled document*. You will not be automatically informed of updates. Any future updates of this document will be included on the DSE website at [www.deepseapl.com](http://www.deepseapl.com)

The DSEExx series is designed to provide differing levels of functionality across a common platform. This allows the engine OEM greater flexibility in the choice of controller to use for a specific application.

The DSEE400 module has been designed to allow the operator to start and stop the engine, control engine speed manually or automatically and if required, transfer the load to engine either manually or automatically.

The user also has the facility to view the system operating parameters via the LCD display.

The DSEE400 module monitors the engine, indicating the operational status and fault conditions, automatically shutting down the engine and giving a true first up fault condition of an engine failure by the LCD display.

The powerful ARM microprocessor contained within the module allows for incorporation of a range of complex features:

- *Text based LCD display*
- *USB Communications*
- *Engine parameter monitoring.*
- *Fully configurable inputs for use as alarms or a range of different functions.*
- *Engine ECU interface to **electronic engines**.*



Using a PC and the DSE Configuration Suite software allows alteration of selected operational sequences, timers, alarms and operational sequences. Additionally, the module's integral front panel configuration editor allows adjustment of this information.

Access to critical operational sequences and timers for use by qualified engineers, can be protected by a security code. Module access can also be protected by PIN code. Selected parameters can be changed from the module's front panel.

The module is housed in a robust plastic case suitable for panel mounting. Connections to the module are via locking plug and sockets.

## 1.1 CLARIFICATION OF NOTATION

Clarification of notation used within this publication.

 <b>NOTE:</b>	Highlights an essential element of a procedure to ensure correctness.
 <b>CAUTION!</b>	Indicates a procedure or practice, which, if not strictly observed, could result in damage or destruction of equipment.
 <b>WARNING!</b>	Indicates a procedure or practice, which could result in injury to personnel or loss of life if not followed correctly.

## 1.2 GLOSSARY OF TERMS

Term	Description
DSEE000, DSEExxx	All modules in the DSEExxx range.
DSEE400	DSEE400 module/controller
CAN	Controller Area Network Vehicle standard to allow digital devices to communicate to one another.
BMS	Building Management System A digital/computer-based control system for a building's infrastructure.
DEF	Diesel Exhaust Fluid (AdBlue) A liquid used as a consumable in the SCR process to lower nitric oxide and nitrogen dioxide concentration in engine exhaust emissions.
DM1	Diagnostic Message 1 A DTC that is currently active on the engine ECU.
DM2	Diagnostic Message 2 A DTC that was previously active on the engine ECU and has been stored in the ECU's internal memory.
DPF	Diesel Particulate Filter A filter fitted to the exhaust of an engine to remove diesel particulate matter or soot from the exhaust gas.
DPTC	Diesel Particulate Temperature Controlled Filter A filter fitted to the exhaust of an engine to remove diesel particulate matter or soot from the exhaust gas which is temperature controlled.
DTC	Diagnostic Trouble Code The name for the entire fault code sent by an engine ECU.
ECU/ECM	Engine Control Unit/Management An electronic device that monitors engine parameters and regulates the fuelling.
FMI	Failure Mode Indicator A part of DTC that indicates the type of failure, e.g. high, low, open circuit etc.

Continued over page...

<b>Term</b>	<b>Description</b>
HEST	High Exhaust System Temperature Initiates when DPF filter is full in conjunction with an extra fuel injector in the exhaust system to burn off accumulated diesel particulate matter or soot.
HMI	Human Machine Interface A device that provides a control and visualisation interface between a human and a process or machine.
OC	Occurrence Count A part of DTC that indicates the number of times that failure has occurred.
PGN	Parameter Group Number A CAN address for a set of parameters that relate to the same topic and share the same transmission rate.
PLC	Programmable Logic Controller A programmable digital device used to create logic for a specific purpose.
PWM	Pulse Width Modulation A digital output control signal used to create a square wave signal switching between on and off within a voltage range over time used for precise control.
SCADA	Supervisory Control And Data Acquisition A system that operates with coded signals over communication channels to provide control and monitoring of remote equipment
SCR	Selective Catalytic Reduction A process that uses DEF with the aid of a catalyst to convert nitric oxide and nitrogen dioxide into nitrogen and water to reduce engine exhaust emission.
SPN	Suspect Parameter Number A part of DTC that indicates what the failure is, e.g. oil pressure, coolant temperature, turbo pressure etc.

### 1.3 BIBLIOGRAPHY

This document refers to, and is referred by the following DSE publications which are obtained from the DSE website: [www.deepseapl.com](http://www.deepseapl.com) or by contacting DSE technical support: [support@deepseapl.com](mailto:support@deepseapl.com).

#### 1.3.1 INSTALLATION INSTRUCTIONS

Installation instructions are supplied with the product in the box and are intended as a 'quick start' guide only.

DSE Part	Description
053-175	DSE9474/9484 Installation Instructions
053-180	DSEE400 Installation Instructions
053-235	DSE 9476 Installation Instructions
053-251	DSE BC2410Ei Installation Instructions
053-277	DSE 9470 MKII Installation Instructions

#### 1.3.2 TRAINING GUIDES

Training guides are provided as 'hand-out' sheets on specific subjects during training sessions and contain specific information regarding to that subject.

DSE Part	Description
056-006	Introduction to Comms
056-017	PC Configuration Interfacing
056-023	Adding New CAN Files
056-028	Smoke Limiting
056-030	Module PIN Codes
056-051	Sending DSEGencomm Control Keys
056-055	Alternate Configurations
056-069	Firmware Update
056-075	Adding Language Files
056-076	Reading DSEGencomm Alarms
056-079	Reading DSEGencomm Status
056-080	MODBUS
056-081	Screen Heaters
056-092	Best Practices for Wiring Resistive Sensors

### 1.3.3 MANUALS

Product manuals are obtained from the DSE website: [www.deepseapl.com](http://www.deepseapl.com) or by contacting DSE technical support: [support@deepseapl.com](mailto:support@deepseapl.com).

<b>DSE Part</b>	<b>Description</b>
N/A	DSEGencomm (MODBUS protocol for DSE controllers)
057-004	Electronic Engines and DSE wiring
057-151	DSE Configuration Suite PC Software Installation & Operation Manual
057-220	Options for Communications with DSE Controllers
057-231	DSE9474/9484 Operator Manual
057-252	DSEE400 Operator Manual
057-282	DSE 9476 Operator Manual
057-291	DSE9470 MKII Operator Manual
057-314	Advanced PLC Programming Guide for DSE Modules
057-315	DSE BC2410Ei Configuration Suite PC Software Manual
057-316	DSE BC2410Ei Operator Manual

## 2 SPECIFICATION

### 2.1 OPERATING TEMPERATURE

Module	Specification
DSEE400	-30 °C +80 °C (-22 °F +176 °F)
Display Heater Variant	-40 °C +80 °C (-40 °F +176 °F)

#### 2.1.1 SCREEN HEATER OPERATION

Screen Heater Function	Specification
Turn On When Temperature Falls Below	-10 °C (+14 °F)
Turn Off When Temperature Rises Above	-5 °C (+23 °F)

### 2.2 REQUIREMENTS FOR UL

Description	Specification
Conductors	Terminals suitable for connection of conductor size 16 AWG (1.3 mm <sup>2</sup> ) Conductor protection must be provided in accordance with NFPA 70, Article 240 or UL 2200 section 29. Low voltage circuits (35 V or less) must be supplied from the engine starting battery or an isolated secondary circuit.
Communication Circuits	Must be connected to communication circuits of UL Listed equipment
Output Pilot Duty	0.5 A
Mounting	Suitable for use in type 1 Enclosure Type rating Suitable for pollution degree 2 environments.
Operating Temperature	-22 °F to +122 °F (-30 °C to +50 °C)
Storage Temperature	-40 °F to +176 °F (-40 °C to +80 °C)

### 2.3 TERMINAL SPECIFICATION

**NOTE:** DSE supply the female Deutsch connectors and socket terminals. Refer to the section entitled *Maintenance, Spares, Repair and Servicing* elsewhere in this document.

Description	Specification	
Arrangement	Two-part Deutsch connector. Male part fitted to module; female part not supplied. Deutsch socket terminals not supplied.	 <p>Example showing a DT16-18SA-K004 connector</p>
Connector A	DT16-18SA-K004	
Connector C	DT16-18SC-K004	
Connector A Socket Terminals	0462-201-16141, QTY 17 0.5 mm <sup>2</sup> to 1.5 mm <sup>2</sup> (AWG 20 to AWG 16)  0462-209-16141, QTY 1 2.0 mm <sup>2</sup> (AWG 14)	
Connector C Socket Terminals	0462-201-16141, QTY 16 0.5 mm <sup>2</sup> to 1.5 mm <sup>2</sup> (AWG 20 to AWG 16)  0462-209-16141, QTY 2 2.0 mm <sup>2</sup> (AWG 14)	

## 2.4 POWER SUPPLY REQUIREMENTS

### 2.4.1 MODULE SUPPLY

Description	Specification
Minimum Supply Voltage	5 V continuous
Cranking Dropouts	Able to survive 0 V for 100 ms providing the supply was at least 10 V before the dropout and recovers to 5 V afterwards. LEDs and backlight will not be maintained during engine cranking; however, inputs and outputs remain active.
Maximum Supply Voltage	35 V continuous
Reverse Polarity Protection	-24 V continuous
Maximum Operating Current	326 mA at 12 V 164 mA at 24 V
Maximum Standby Current	119 mA at 12 V 60 mA at 24 V
Maximum Current in Sleep Mode	76 mA at 12 V 38 mA at 24 V
Typical Display Heater Power	3.5 W

#### 2.4.1.1 MODULE SUPPLY INSTRUMENTATION DISPLAY

Description	Specification
Range	0 V to 70 V DC (Maximum continuous operating voltage of 35 V DC)
Resolution	0.1 V
Accuracy	1 % full scale ( $\pm 0.35$ V)

### 2.4.2 PWMI SUPPLY

Description	Specification
Minimum Supply Voltage	5 V continuous
Maximum Supply Voltage	35 V continuous
Reverse Polarity Protection	-24 V continuous
Maximum Average Current	8 A
Maximum Peak Current	12 A

## 2.5 INPUTS

### 2.5.1 DIGITAL INPUTS

Description	Specification
Number	4 configurable digital inputs
Activation	Configurable in banks of 2 as positive or negative switching
Contact Wetting Current	5 mA typical
Maximum Input Voltage	+35 V DC with respect to module supply negative
Minimum Input Voltage	-24 V DC with respect to module supply negative

#### 2.5.1.1 POSITIVE SWITCHING CONFIGURATION

Description	Specification
Arrangement	Contact between terminal and a positive supply with respect to the module supply negative
Closed Threshold	8.1 V minimum
Open Threshold	3.2 V maximum
Open Circuit Voltage	0 V typical

#### 2.5.1.2 NEGATIVE SWITCHING CONFIGURATION

Description	Specification
Arrangement	Contact between terminal and module supply negative
Closed Threshold	3.2 V maximum
Open Threshold	8.1 V minimum
Open Circuit Voltage	11 V typical

### 2.5.2 EMERGENCY STOP

Description	Specification
Arrangement	Contact between terminal and module supply positive
Closed Threshold	5 V minimum
Open Threshold	3 V maximum
Maximum Input Voltage	+35 V DC with respect to plant supply negative
Minimum Input Voltage	-24 V DC with respect to plant supply negative
Open Circuit Voltage	0 V

### 2.5.3 ANALOGUE INPUTS

All the analogue inputs are flexible within the module.

#### 2.5.3.1 ANALOGUE INPUT A

Description	Specification
Input Type	Flexible: Configured for <i>Oil Sensor</i> in the DSE default configuration. Flexible Options: Not used, Digital Input and Flexible Analogue
Flexible Input Selection	Pressure Sensor Percentage Sensor Temperature Sensor
Flexible Measured Quantity	Current Resistive Voltage

#### Resistive Configuration

Description	Specification
Measurement Type	Resistance measurement by measuring voltage across sensor with a fixed current applied
Arrangement	Differential resistance measurement input
Measurement Current	15 mA $\pm$ 10 %
Full Scale	0 $\Omega$ to 240 $\Omega$
Over Range / Fail	350 $\Omega$
Open Circuit	1 k $\Omega$
Resolution	1 % of full scale
Accuracy	$\pm$ 2 % of full-scale resistance ( $\pm$ 4.8 $\Omega$ ) excluding sensor error
Max Common Mode Voltage	$\pm$ 2 V
Display Range	Configurable by PC Software

#### 0 V to 10 V Configuration

Description	Specification
Full Scale	0 V to 10 V
Over Range / Fail	11 V
Resolution	1% of full scale
Accuracy	$\pm$ 2% of full-scale voltage ( $\pm$ 0.2 V) excluding sensor error
Max Common Mode Voltage	$\pm$ 2 V
Display Range	Configurable by PC Software

#### 4 mA to 20 mA Configuration

Description	Specification
Full Scale	0 mA to 20 mA
Over Range / Fail	22 mA
Resolution	1% of full scale
Accuracy	$\pm$ 2% of full-scale current ( $\pm$ 0.4 mA) excluding sensor error
Max Common Mode Voltage	$\pm$ 2 V
Display Range	Configurable by PC Software

**2.5.3.2 ANALOGUE INPUT B TO G**

Description	Specification
Analogue Input B Type	Flexible: Configured for <i>Temperature Sensor</i> in the DSE default configuration. Flexible Options: Not used, Digital Input and Flexible Analogue
Analogue Input C Type	Flexible: Configured for <i>Fuel Sensor</i> in the DSE default configuration. Flexible Options: Not used, Digital Input and Flexible Analogue
Analogue Input D to G Type	Flexible: Configured for <i>Flexible Analogue</i> in the DSE default configuration. Flexible Options: Not used, Digital Input and Flexible Analogue
Flexible Input Selection	Pressure Sensor Percentage Sensor Temperature Sensor
Flexible Measured Quantity	Current Resistive Voltage

**Resistive Configuration**

Description	Specification
Measurement Type	Resistance measurement by measuring voltage across sensor with a fixed current applied
Arrangement	Differential resistance measurement input
Measurement Current	10 mA $\pm$ 10 %
Full Scale	0 $\Omega$ to 480 $\Omega$
Over Range / Fail	600 $\Omega$
Resolution	1 % of full scale
Accuracy	$\pm$ 2 % of full-scale resistance ( $\pm$ 9.6 $\Omega$ ) excluding sensor error
Max Common Mode Voltage	$\pm$ 2 V
Display Range	Configurable by PC Software

**0 V to 10 V Configuration**

Description	Specification
Full Scale	0 V to 10 V
Resolution	1% of full scale
Accuracy	$\pm$ 2% of full-scale voltage ( $\pm$ 0.2 V) excluding sensor error
Max Common Mode Voltage	$\pm$ 2 V
Display Range	Configurable by PC Software

**4 mA to 20 mA Configuration**

Description	Specification
Full Scale	0 mA to 20 mA
Resolution	1% of full scale
Accuracy	$\pm$ 2% of full-scale current ( $\pm$ 0.4 mA) excluding sensor error
Max Common Mode Voltage	$\pm$ 2 V
Display Range	Configurable by PC Software

### 2.5.4 CHARGE FAIL INPUT

The charge fail input is a combined input and output. Whenever the engine is required to run, the terminal provides excitation current to the charge alternator field winding.

When the charge alternator is correctly charging the battery, the voltage of the terminal is close to the plant battery supply voltage. In a failed charge situation, the voltage of this terminal is pulled down to a low voltage. It is this drop in voltage that triggers the *Charge Failure* alarm. The level at which this operates and whether this triggers a warning or shutdown alarm is configurable using the DSE Configuration Suite Software.

Description	Specification
Minimum Voltage	0 V
Maximum Voltage	35 V
Resolution	0.2 V
Accuracy	±1 % of full scale
Excitation	Active circuit constant power output
Output Power	2.5 W nominal at module supply
Current At 12V	210 mA
Current At 24V	105 mA

### 2.5.5 MAGNETIC PICKUP

 **NOTE: DSE supply a suitable magnetic pickup device, available in two body thread lengths:**  
**DSE Part number 020-012 - Magnetic Pickup probe 5/8 UNF 2 1/2" thread length**  
**DSE Part number 020-013 - Magnetic Pickup probe 5/8 UNF 4" thread length**

Magnetic Pickup devices can often be 'shared' between two or more devices. For example, one device can often supply the signal to both the DSE module and the engine governor. The possibility of this depends upon the amount of current that the magnetic pickup can supply.

Description	Specification
Type	Differential input
Minimum Voltage	0.5 V RMS
Maximum Voltage	60 V RMS
Max Common Mode Voltage	±2 V peak
Minimum Frequency	5 Hz
Maximum Frequency	10,000 Hz
Resolution	6.25 RPM
Accuracy	±25 RPM
Flywheel Teeth	10 to 500
Open Circuit Voltage	4 V DC typical

## 2.6 OUTPUTS

### 2.6.1 DC OUTPUTS A & B (FUEL & START)

Description	Specification
Type	Normally used as Fuel & Start outputs. Fully configurable for other purposes if the module is configured to control an electronic engine.
Rating	10 A for 10 seconds, 5 A continuous at <i>Emergency Stop</i> supply.

### 2.6.2 CONFIGURABLE DC OUTPUTS C & D

Description	Specification
Type	Fully configurable, supplied from module supply.
Rating	2 A resistive at module supply.

### 2.6.3 CONFIGURABLE PWMI OUTPUTS E & F

#### 2.6.3.1 CONFIGURED AS DC OUTPUTS

Description	Specification
Type	Fully configurable, supplied from PWMi supply.
Rating	4 A resistive at PWMi supply.

#### 2.6.3.2 CONFIGURED AS PWMI OUTPUTS

Description	Specification
Type	Fully configurable, supplied from PWMi supply.
Rating (250 Hz to 500 Hz)	2 A resistive at PWMi supply.
Rating (0 Hz to 250 Hz)	4 A resistive at PWMi supply.
Minimum Frequency	20 Hz
Maximum Frequency	500 Hz
Minimum Load Impedance	3 $\Omega$ at 12 V, 6 $\Omega$ at 24 V,
Accuracy	$\pm 1$ % of full scale
Resolution	1 mA for 0 A to 2 A range, 2 mA for 0 A to 4 A range.
Minimum Voltage	5 V DC

### 2.6.4 GOVERNOR OUTPUT

#### 2.6.4.1 0 V TO 10 V CONFIGURATION

Description	Specification
Output Range	0 V to 10 V floating.
Minimum Load Impedance	1 k $\Omega$
Resolution	5 mV
Accuracy	$\pm 1$ % of full scale

**2.6.4.2 0 MA TO 20 MA CONFIGURATION**

Description	Specification
Output Range	0 mA to 20 mA floating.
Maximum Load Impedance	500 Ω
Resolution	5 μA
Accuracy	±1 % of full scale

**2.7 COMMUNICATION PORTS**

 **NOTE: All communication ports can be used at the same time.**

Description	Specification
USB Slave Port	Type B USB 2.0 For connection to PC running DSE Configuration Suite Max distance 6 m (20 feet)
RS485 Serial Port	Isolated Data connection 2 wire + common Half Duplex Data direction control for Transmit (by s/w protocol) Max Baud Rate 115 kbaud subject to configuration External termination required (120 Ω) Max common mode offset 70 V (on board protection transorb) Max distance 1.2 km (¾ mile)
ECU Port	<div data-bbox="523 1021 1414 1144" style="border: 1px solid black; padding: 5px;">  <b>NOTE: For additional length, the DSE124 CAN Extender is available. For more information, refer to DSE Publication: 057-116 DSE124 Operator Manual</b> </div> Engine CAN Port Standard implementation of 'Slow mode', up to 250K bits/s Non-Isolated. Internal Termination provided (120Ω) Max distance 40 m (133 feet)

## 2.8 COMMUNICATION PORT USAGE

### 2.8.1 USB SLAVE PORT (PC CONFIGURATION)

**NOTE:** DSE stock 2 m (6.5 feet) USB type A to type B cable, DSE Part Number: 016-125. Alternatively, they are purchased from any PC or IT store.

**NOTE:** The DC supply must be connected to the module for configuration by PC.

**NOTE:** For further details of module configuration, refer to DSE Publication: 057-251 *DSEE400 Configuration Software Manual*.

The USB port is provided to give a simple means of connection between a PC and the controller. Using the DSE Configuration Suite Software, the operator is then able to control the module, starting or stopping the engine, selecting operating modes, etc.

Additionally, the various operating parameters (such as coolant temperature, oil pressure, etc.) of the engine are available to be viewed or changed.

To connect a module to a PC by USB, the following items are required:

DSEE400 Controller



DSE Configuration Suite PC Software  
(Supplied on configuration suite software CD or available from [www.deepseapl.com](http://www.deepseapl.com)).



USB cable Type A to Type B.  
(This is the same cable as often used between a PC and a USB printer)



## 2.8.2 RS485 PORT

The RS485 port on the controller supports the MODBUS RTU protocol and is for connection to a single MODBUS client device only.

The DSE MODBUS register table for the controller is available upon request from the DSE Technical Support Department.

RS485 is used for point-to-point cable connection of more than one device (maximum 32 devices) and allows for connection to PCs, PLCs and Building Management Systems (to name just a few devices).

One advantage of the RS485 interface is the large distance specification (1.2 km when using Belden 9841 (or equivalent) cable). This allows for a large distance between the module and a PC running the DSE Configuration Suite software. The operator is then able to control the module, starting or stopping the engine, selecting operating modes, etc.

The various operating parameters (such as coolant temperature, oil pressure, etc.) of the remote engine are viewed or changed.

**NOTE:** For a single module to PC connection and distances up to 6 m (20 feet) the USB connection method is more suitable and provides for a lower cost alternative to RS485 (which is more suited to longer distance connections).

Many PCs are not fitted with an internal RS485 serial port. DSE DOES NOT recommend the use of USB to RS485 converters but can recommend PC add-ons to provide the computer with an RS485port.

### 2.8.2.1 CABLE SPECIFICATION

**NOTE:** DSE recommend Belden 9841 (or equivalent) cable for RS485 communication. This is rated to a maximum cable length of 1.2 km. DSE Stock Belden 9841 cable, DSE Part Number: 016-030.

Description	Specification
Cable Type	Two core screened and shielded twisted pair
Cable Characteristics	120 Ω impedance Low capacitance
Recommended Cable	Belden 9841 Belden 9271
Maximum Cable Length	1200 m (¾ mile) when using Belden 9841 or direct equivalent. 600 m (656 yards) when using Belden 9271 or direct equivalent.
RS485 Topology	“Daisy Chain” Bus with no stubs (spurs)
RS485 Termination	120 Ω. Not fitted internally to module. Must be fitted externally to the ‘first’ and ‘last’ device on the RS485 link.

### 2.8.2.2 RECOMMENDED PC RS485 SERIAL PORT ADD-ONS

**NOTE:** DSE have no business tie to Brainboxes. Over many years, our own engineers have used these products and are happy to recommend them.

**NOTE:** For further details of setting up the devices below, refer to the manufacture whose details are below.

Remember to check these parts are suitable for your PC. Consult your PC supplier for further advice.

Brainboxes PM154 PCMCIA RS485 card (for laptops PCs)  
Set to 'Half Duplex, Autogating" with 'CTS True' set to 'enabled'



Brainboxes UC320 PCI Velocity RS485 card (for desktop PCs)  
Set to 'Half Duplex, Autogating" with 'CTS True' set to 'enabled'



Brainboxes PX-324 PCI Express 1 Port RS422/485 (for desktop PCs)



Supplier:  
Brainboxes  
**Tel:** +44 (0)151 220 2500  
**Web:** <http://www.brainboxes.com>  
**Email:** Sales: [sales@brainboxes.com](mailto:sales@brainboxes.com)

### 2.8.3 ECU PORT (J1939)

**NOTE:** For further details on connection to electronic engines, refer to DSE Publication: *057-004 Electronic Engines And DSE Wiring*

**NOTE:** Screened 120  $\Omega$  impedance cable specified for use with CAN must be used for the CAN link.  
DSE stock and supply Belden cable 9841 which is a high quality 120  $\Omega$  impedance cable suitable for CAN use (DSE part number 016-030)

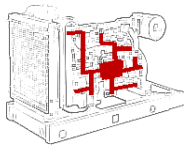

The modules are fitted with a CAN interface as standard and can receive engine data from engine ECU/ECMs compliant with the CAN J1939 standard.

ECU/ECMs monitor the engine's operating parameters such as speed, oil pressure, coolant temperature (among others) to closely monitor and control the engine. The industry standard communications interface (CAN) transports data gathered by the engine's ECU/ECM using the J1939 protocol. This allows engine controllers such as DSE to access these engine parameters with no physical connection to the sensor device.

The *ECU Port* is used for point-to-point cable connection of more than one device and allows for connection to CAN Scanner, PLC and CAN controllers (to name just a few devices). The operator is then able to view the various operating parameters.

## 2.9 ADDING AN EXTERNAL SOUNDER

Should an external alarm or indicator be required, this can be achieved by using the DSE Configuration Suite PC software to configure an auxiliary output for *Audible Alarm*, and by configuring an auxiliary input for *Alarm Mute* (if required).

Example of configuration to achieve external sounder with external alarm mute button:

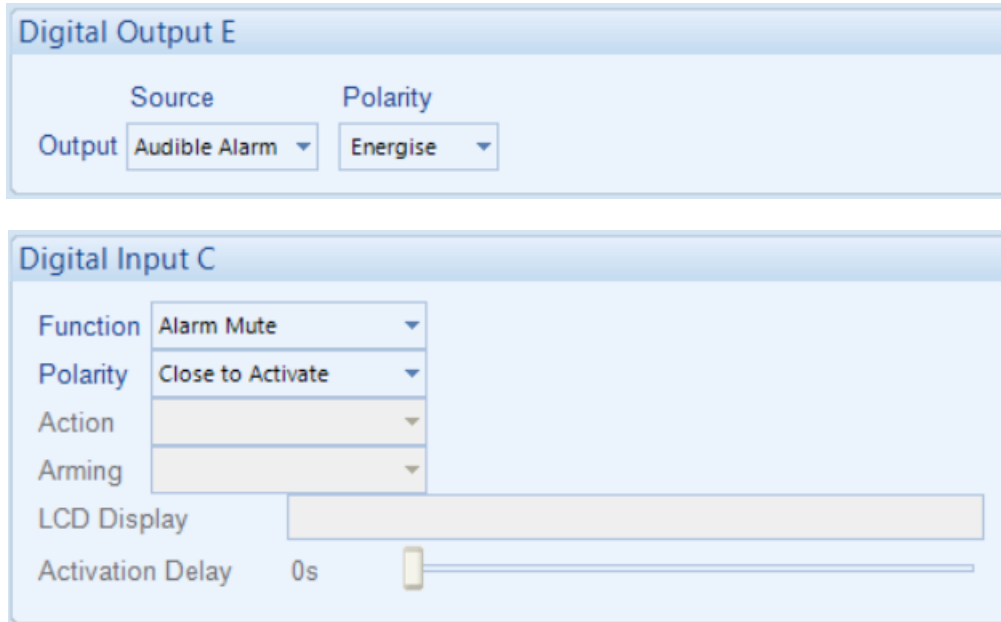

## 2.10 ACCUMULATED INSTRUMENTATION

**NOTE:** When an accumulated instrumentation value exceeds the maximum number as listed below, the value is reset and begins counting from zero again.

The number of logged *Engine Hours* and *Number of Starts* can be set/reset using the DSE Configuration Suite PC software. Depending upon module configuration, this may have been PIN number locked by the engine supplier.

Description	Specification
Engine Hours Run	Maximum 99999 hrs 59 minutes (Approximately 11yrs 4 months)
Number of Starts	99,999

## 2.11 DIMENSIONS AND MOUNTING

### 2.11.1 DIMENSIONS

189 mm x 125 mm x 54 mm  
(7.5 " x 4.9 " x 2.1 ")

### 2.11.2 PANEL CUTOUT

148 mm x 112 mm  
(5.8 " x 4.4 ")

### 2.11.3 MOUNTING HOLE SPACING

165 mm x 68 mm  
(6.5 " x 2.7 ")

### 2.11.4 MOUNTING DIAMETER

Suitable for M4  
(5/32 " diameter)

### 2.11.5 WEIGHT

0.4 kg  
(0.88 lb)

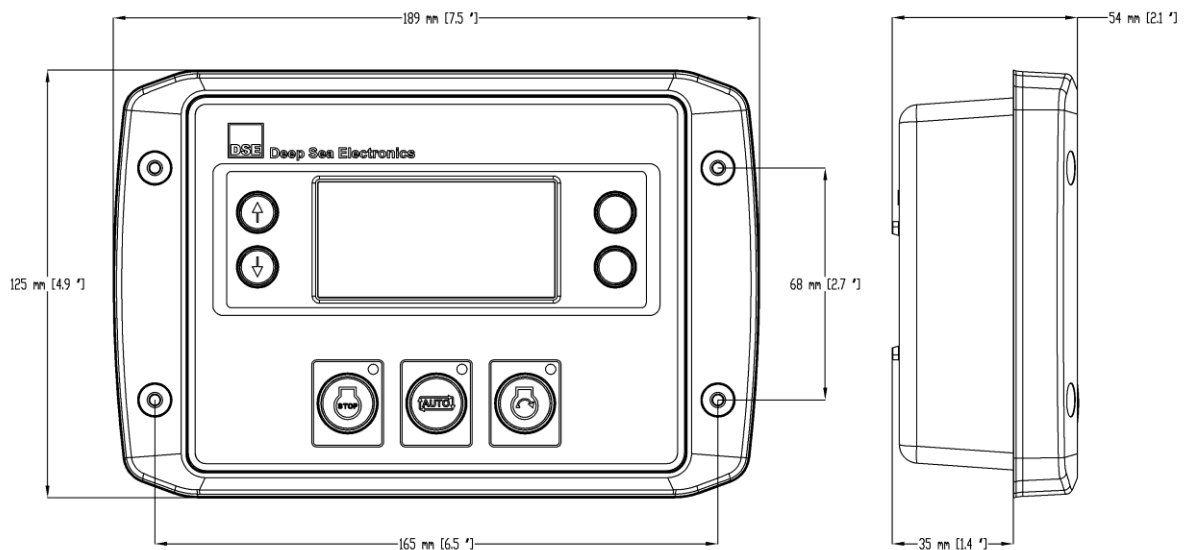

### 2.11.6 SILICON SEALING GASKET

The silicon gasket is moulded into the module's case and provides improved sealing between module and panel fascia.



## 2.12 APPLICABLE STANDARDS

Standard	Description
BS 4884-1	This document conforms to BS4884-1 1992 Specification for presentation of essential information.
BS 4884-2	This document conforms to BS4884-2 1993 Guide to content
BS 4884-3	This document conforms to BS4884-3 1993 Guide to presentation
BS EN 60068-2-1 (Minimum temperature)	-30 °C (-22 °F)
BS EN 60068-2-2 (Maximum temperature)	+80 °C (178 °F)
BS EN 60950	Safety of information technology equipment, including electrical business equipment
BS EN 61000-6-2	EMC Generic Immunity Standard (Industrial)
BS EN 61000-6-4	EMC Generic Emission Standard (Industrial)
BS EN 60529 (Degrees of protection provided by enclosures)	IP67 (Front and back of module when installed into a control panel with connectors mated and USB bung seal inserted).
UL508 NEMA rating (Approximate)	6 (Front and back of module when installed into a control panel with connectors mated and USB bung seal inserted).
IEEE C37.2 (Standard Electrical Power System Device Function Numbers and Contact Designations)	<p>Under the scope of IEEE 37.2, function numbers can also be used to represent functions in microprocessor devices and software programs. The controller is device number 11L-8000 (Multifunction device protecting Line (engine) –module).</p> <p>As the module is configurable by the engine OEM, the functions covered by the module vary. Depending on module configuration, the device numbers included within the module could be:</p> <ul style="list-style-type: none"> <li>2 – Time Delay Starting Or Closing Relay</li> <li>5 – Stopping Device</li> <li>6 – Starting Circuit Breaker</li> <li>11 – Multifunction Device</li> <li>12 – Overspeed Device</li> <li>14 – Underspeed Device</li> <li>18 – Accelerating or Decelerating Device</li> <li>19 – Starting-to-running transition contactor</li> <li>26 – Apparatus Thermal Device</li> <li>27DC – DC Undervoltage Relay</li> <li>29 – Isolating Contactor Or Switch</li> <li>30 – Annunciator Relay</li> <li>54 – Turning Gear Engaging Device</li> <li>59DC – DC Overvoltage Relay</li> <li>62 – Time Delay Stopping Or Opening Relay</li> <li>63 – Pressure Switch</li> <li>71 – Level Switch</li> <li>74 – Alarm Relay</li> <li>83 – Automatic Selective Control Or Transfer Relay</li> <li>86 – Lockout Relay</li> </ul>

In line with our policy of continual development, Deep Sea Electronics, reserve the right to change specification without notice.

## 2.12.1 ENCLOSURE CLASSIFICATIONS

### 2.12.1.1 IP CLASSIFICATIONS

The modules specification under BS EN 60529 Degrees of protection provided by enclosures

**IP67 (Front and back of module when installed into a control panel with connectors mated and USB bung seal inserted).**

First Digit	Second Digit
Protection against contact and ingress of solid objects	Protection against ingress of water
0 No protection	0 No protection
1 Protected against ingress solid objects with a diameter of more than 50 mm. No protection against deliberate access, e.g. with a hand, but large surfaces of the body are prevented from approach.	1 Protection against dripping water falling vertically. No harmful effect must be produced (vertically falling drops).
2 Protected against penetration by solid objects with a diameter of more than 12 mm. Fingers or similar objects prevented from approach.	2 Protection against dripping water falling vertically. There must be no harmful effect when the equipment (enclosure) is tilted at an angle up to 15° from its normal position (drops falling at an angle).
3 Protected against ingress of solid objects with a diameter of more than 2.5 mm. Tools, wires etc. with a thickness of more than 2.5 mm are prevented from approach.	3 Protection against water falling at any angle up to 60° from the vertical. There must be no harmful effect (spray water).
4 Protected against ingress of solid objects with a diameter of more than 1 mm. Tools, wires etc. with a thickness of more than 1 mm are prevented from approach.	4 Protection against water splashed against the equipment (enclosure) from any direction. There must be no harmful effect (splashing water).
5 Protected against harmful dust deposits. Ingress of dust is not totally prevented but the dust must not enter in sufficient quantity to interface with satisfactory operation of the equipment. Complete protection against contact.	5 Protection against water projected from a nozzle against the equipment (enclosure) from any direction. There must be no harmful effect (water jet).
6 Protection against ingress of dust (dust tight). Complete protection against contact.	6 Protection against heavy seas or powerful water jets. Water must not enter the equipment (enclosure) in harmful quantities (splashing over).
	7 Protection against the effects of temporary immersion in water.

### 2.12.1.2 NEMA CLASSIFICATIONS

 **NOTE: There is no direct equivalence between IP / NEMA ratings. IP figures shown are approximate only.**

**6 (Front and back of module when installed into a control panel with connectors mated and USB bung seal inserted).**

1 <b>IP30</b>	Provides a degree of protection against contact with the enclosure equipment and against a limited amount of falling dirt.
2 <b>IP31</b>	Provides a degree of protection against limited amounts of falling water and dirt.
3 <b>IP64</b>	Provides a degree of protection against windblown dust, rain and sleet; undamaged by the formation of ice on the enclosure.
3R <b>IP32</b>	Provides a degree of protection against rain and sleet: undamaged by the formation of ice on the enclosure.
4 (X) <b>IP66</b>	Provides a degree of protection against splashing water, windblown dust and rain, hose directed water; undamaged by the formation of ice on the enclosure. (Resist corrosion).
6 <b>IP67</b>	Provides a degree of protection against temporary submersion in water. Not intended for continuous submersion.
12/12K <b>IP65</b>	Provides a degree of protection against dust, falling dirt and dripping non corrosive liquids.
13 <b>IP65</b>	Provides a degree of protection against dust and spraying of water, oil and non corrosive coolants.

### 3 INSTALLATION

The module is designed to be mounted on the panel fascia. For dimension and mounting details, see the section entitled *Dimension and Mounting* elsewhere in this document.

#### 3.1 USER CONNECTIONS

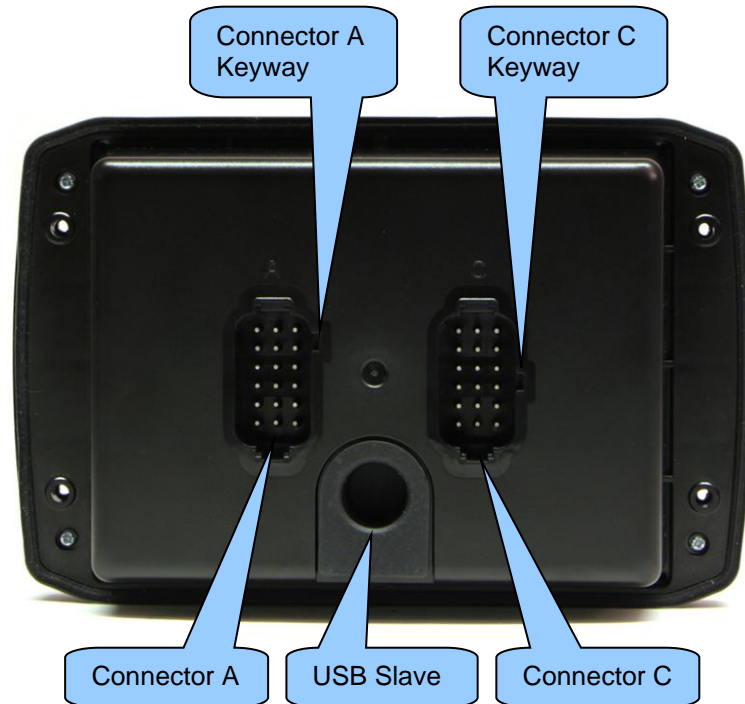

#### 3.2 CONNECTION DESCRIPTIONS

**NOTE:** It is VERY important that terminals A11 & C4 (sensor commons) are connected to an earth point on the ENGINE BLOCK, not within the control panel, and must be a sound electrical connection to the sensor bodies. This connection MUST NOT be used to provide an earth connection for other terminals or devices. The simplest way to achieve this is to run a SEPARATE earth connection from the system earth star point, to terminals A11 & C4 directly, and not use this earth for other connections.

**NOTE:** If PTFE insulating tape is used on the sensor thread when using earth return sensors, ensure not to insulate the entire thread, as this prevents the sensor body from being earthed via the engine block.

### 3.2.1 CONNECTOR A

**NOTE:** When the module is configured for operation with an electronic engine, *Fuel* and *Start* output requirements may be different. For further details on connection to electronic engines, refer to DSE Publication: *057-004 Electronic Engines and DSE Wiring*

**NOTE:** Screened 120 Ω impedance cable specified for use with CAN must be used for the CAN link. DSE stock and supply Belden cable 9841 which is a high quality 120 Ω impedance cable suitable for CAN use (DSE part number 016-030)

**NOTE:** For further details on connection to electronic engines, refer to DSE Publication: *057-004 Electronic Engines And DSE Wiring*

**NOTE:** For further details of module configuration, refer to DSE Publication: *057-251 DSEE400 Configuration Software Manual*.

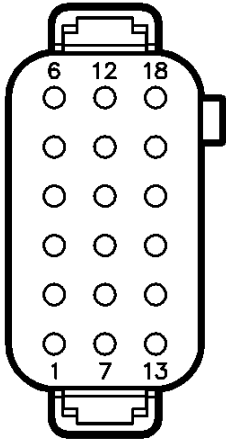
DT16-18SA-K004 Connector	Pin No	Description	Cable Size	Notes
	A1	DC Output C	1.0 mm <sup>2</sup> AWG 17	Plant Supply Positive from terminal A7. 2 A DC rated.
	A2	DC Output D	1.0 mm <sup>2</sup> AWG 17	Plant Supply Positive from terminal A7. 2 A DC rated.
	A3	Emergency Stop Input	2.0 mm <sup>2</sup> AWG 14	Plant Supply Positive. Supplies DC Outputs A & B.
	A4	DC Output A (Fuel)	1.5 mm <sup>2</sup> AWG 16	Plant Supply Positive from terminal A3. 5 A DC continuous rated Fixed as fuel relay if electronic engine is not configured.
	A5	DC Output B (Start)	1.5 mm <sup>2</sup> AWG 16	Plant Supply Positive from terminal A3. 5 A DC continuous rated Fixed as start relay if electronic engine is not configured.
	A6	Digital Input A	1.0 mm <sup>2</sup> AWG 17	Switch To Negative or Positive depending upon module configuration.
	A7	DC Plant Supply Input (Positive)	1.0 mm <sup>2</sup> AWG 17	Supplies the module and DC Outputs C & D
	A8	ECU Port Screen	Screen	Use only 120 Ω CAN or RS485 approved cable
	A9	ECU Port L	0.5 mm <sup>2</sup> AWG 20	Use only 120 Ω CAN or RS485 approved cable
	A10	ECU Port H	0.5 mm <sup>2</sup> AWG 20	Use only 120 Ω CAN or RS485 approved cable
	A11	Analogue Sensor A, B ,C & D Common	1.5 mm <sup>2</sup> AWG 16	Ground Return For Analogue Sensors A, B ,C & D.
	A12	Digital Input B	1.0 mm <sup>2</sup> AWG 17	Switch To Negative or Positive depending upon module configuration.
	A13	DC Plant Supply Input (Negative)	1.0 mm <sup>2</sup> AWG 17	Connect to ground where applicable.
	A14	Charge Fail / Excite	1.5 mm <sup>2</sup> AWG 16	Do not connect to ground (battery negative). If charge alternator is not fitted, leave this terminal disconnected.
	A15	Analogue Sensor Input D	1.0 mm <sup>2</sup> AWG 17	Connect To Additional Sensor (User Configurable).
	A16	Analogue Sensor Input C	1.0 mm <sup>2</sup> AWG 17	Connect To Fuel Level Sensor.
	A17	Analogue Sensor Input B	1.0 mm <sup>2</sup> AWG 17	Connect To Coolant Temperature Sensor.
	A18	Analogue Sensor Input A	1.0 mm <sup>2</sup> AWG 17	Connect To Oil Pressure Sensor.

3.2.2 CONNECTOR C

**NOTE:** A 120 Ω termination resistor must be fitted across terminals RS485 A and RS485 B if the DSE module is the first or last device on the R485 link.

**NOTE:** Screened 120 Ω impedance cable specified for use with RS485 must be used for the RS485 link.  
DSE stock and supply Belden cable 9841 which is a high quality 120 Ω impedance cable suitable for CAN use (DSE part number 016-030)

**NOTE:** For further details of module configuration, refer to DSE Publication: 057-251 DSEE400 Configuration Software Manual.

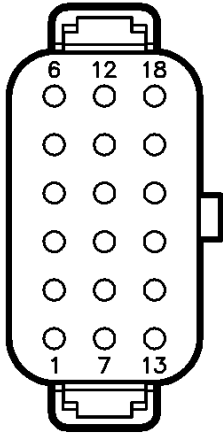

DT16-18SC-K004 Connector	Pin No	Description	Cable Size	Notes
	C1	Governor B	0.5 mm <sup>2</sup> AWG 20	Use Screened Cable
	C2	RS485 A (-)	0.5 mm <sup>2</sup> AWG 20	Use only 120 Ω CAN or RS485 approved cable
	C3	RS485 Screen	Screen	Use only 120 Ω CAN or RS485 approved cable
	C4	Analogue Sensor E, F & G Common	1.5 mm <sup>2</sup> AWG 16	Ground Return For Analogue Sensors E, F & G.
	C5	Analogue Sensor Input E	1.0 mm <sup>2</sup> AWG 17	Connect To Additional Sensor (User Configurable).
	C6	Analogue Sensor Input F	1.0 mm <sup>2</sup> AWG 17	Connect To Additional Sensor (User Configurable).
	C7	Governor A	0.5 mm <sup>2</sup> AWG 20	Use Screened Cable
	C8	RS485 B (+)	0.5 mm <sup>2</sup> AWG 20	Use only 120 Ω CAN or RS485 approved cable
	C9	Magnetic Pickup Positive	0.5 mm <sup>2</sup> AWG 20	Connect To Magnetic Pickup Device. Use Screened Cable.
	C10	Magnetic Pickup Negative	0.5 mm <sup>2</sup> AWG 20	Connect To Magnetic Pickup Device. Use Screened Cable.
	C11	Magnetic Pickup Screen	Screen	Connect To Ground At One End Only
	C12	Analogue Sensor Input G	1.0 mm <sup>2</sup> AWG 17	Connect To Additional Sensor (User Configurable).
	C13	PWMi Supply Input (Negative)	2.0 mm <sup>2</sup> AWG 14	Connect to ground where applicable.
	C14	PWMi Supply Input (Positive)	2.0 mm <sup>2</sup> AWG 14	Supplies the PWMi Outputs E & F.
	C15	PWMi Output F	1.5 mm <sup>2</sup> AWG 16	Plant Supply Positive from terminal C14. 4 A rated.
	C16	PWMi Output E	1.5 mm <sup>2</sup> AWG 16	Plant Supply Positive from terminal C14. 4 A rated.
	C17	Digital Input D	1.0 mm <sup>2</sup> AWG 17	Switch To Negative or Positive depending upon module configuration.
	C18	Digital Input C	1.0 mm <sup>2</sup> AWG 17	Switch To Negative or Positive depending upon module configuration.

### 3.2.3 USB SLAVE (PC CONFIGURATION) CONNECTOR

**NOTE:** The USB connection cable between the PC and the module must not be extended beyond 5 m (yards). For distances over 5 m, it is possible to use a third-party USB extender. Typically, they extend USB up to 50 m. The supply and support of this type of equipment is outside the scope of Deep Sea Electronics Ltd.

**CAUTION!** Care must be taken not to overload the PC's USB system by connecting more than the recommended number of USB devices to the PC. For further information, consult your PC supplier.

**NOTE:** For further details of module configuration, refer to DSE Publication: *057-251 DSEE400 Configuration Software Manual*.

	Description	Cable Size	Notes
	Socket for connection to PC with DSE Configuration Suite Software	0.5 mm <sup>2</sup> AWG 20	This is a standard USB type A to type B connector. 

### 3.3 TYPICAL WIRING DIAGRAM

As every system has different requirements, these diagrams show only a typical system and do not intend to show a complete system.

Set manufacturers and panel builders may use these diagrams as a starting point; however always refer to the completed system diagram provided by the system manufacturer for complete wiring detail.

Further wiring suggestions are available in the following DSE publications, available at [www.deepseapl.com](http://www.deepseapl.com) to website members.

<b>DSE Part</b>	<b>Description</b>
057-004	Electronic Engines and DSE Wiring

# Installation

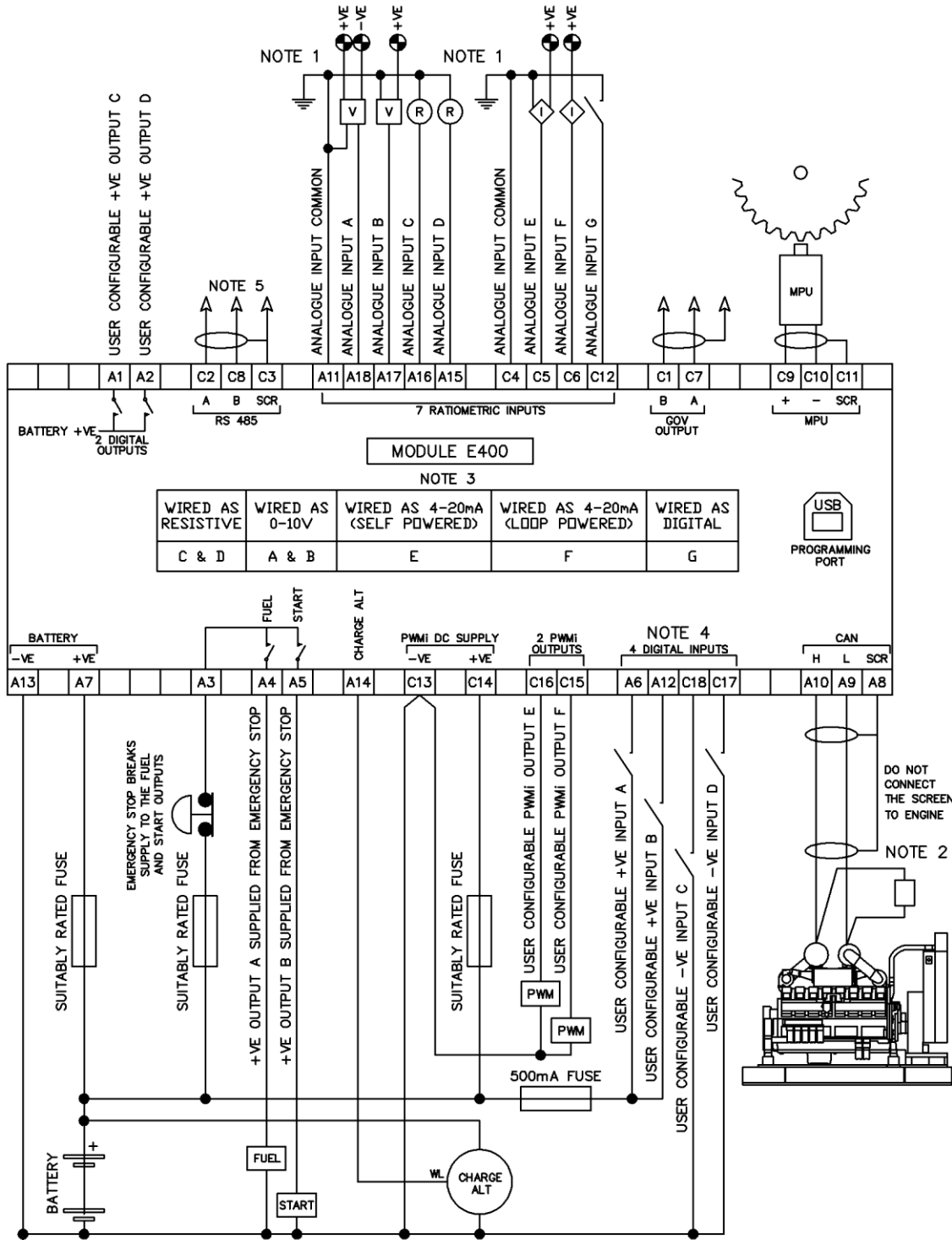

NOTE 3

WIRED AS RESISTIVE	WIRED AS 0-10V	WIRED AS 4-20mA (SELF POWERED)	WIRED AS 4-20mA (LOOP POWERED)	WIRED AS DIGITAL
C & D	A & B	E	F	G

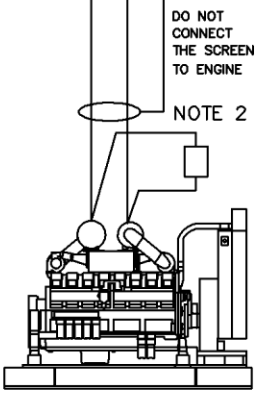

- BATTERY NEGATIVE MUST BE GROUND
- NOTE 1. THESE GROUND CONNECTIONS MUST BE ON THE ENGINE BLOCK, AND MUST BE TO THE SENSOR BODIES.
- NOTE 2. 120 Ω TERMINATING RESISTOR MAY BE REQUIRED EXTERNALLY, SEE ENGINE MANUFACTURERS LITERATURE.
- NOTE 3. ANALOGUE INPUTS CAN BE CONFIGURED AS EITHER A DIGITAL INPUT, RESISTIVE INPUT, 0-10V INPUT, 4-20mA INPUT OR ANY COMBINATION OF THE ABOVE.
- NOTE 4. DIGITAL INPUTS CAN BE CONFIGURED AS EITHER +VE OR -VE SWITCHING.
- NOTE 5. AN EXTERNAL 120 Ω TERMINATING RESISTOR MUST BE FITTED IF THE CONTROLLER IS THE FIRST OR LAST UNIT ON THE RS485 LINK

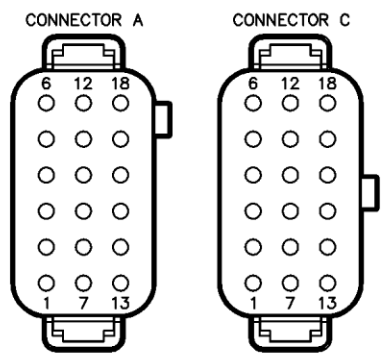

## 3.4 EARTH SYSTEMS

### 3.4.1 NEGATIVE EARTH

The typical wiring diagrams located within this document show connections for a negative earth system (the battery negative connects to Earth).

### 3.4.2 POSITIVE EARTH

When using a DSE module with a Positive Earth System (the battery positive connects to Earth), the following points must be followed:

Follow the typical wiring diagram as normal for all sections **except** the earth points. All points shown as Earth on the typical wiring diagram should connect to **battery negative** (not earth).

### 3.4.3 FLOATING EARTH





Where neither the battery positive nor battery negative terminals are connected to earth the following points must be followed:

Follow the typical wiring diagram as normal for all sections **except** the earth points. All points shown as Earth on the typical wiring diagram should connect to **battery negative** (not earth).

## 4 DESCRIPTION OF CONTROLS

 **CAUTION:** The module may instruct an engine start event due to external influences. Therefore, it is possible for the engine to start at any time without warning. Prior to performing any maintenance on the system, it is recommended that steps are taken to remove the battery and isolate supplies.





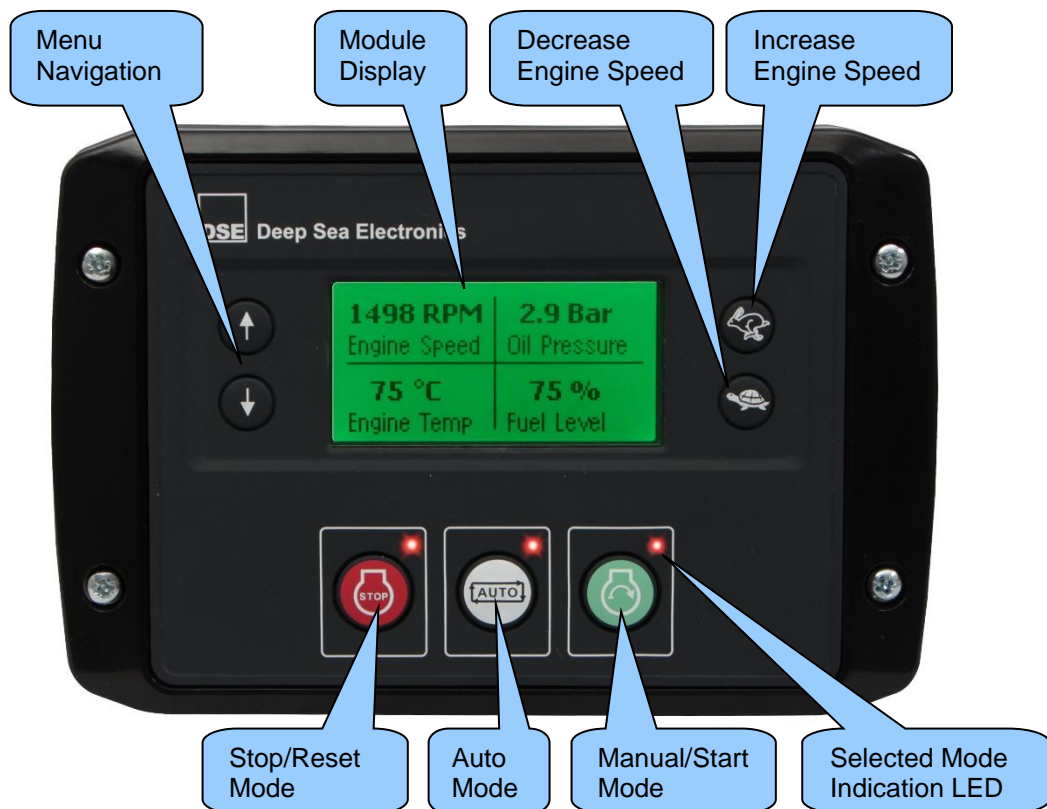











 **NOTE:** The following descriptions detail the sequences followed by a module containing the standard 'factory configuration'. Always refer to your configuration source for the exact sequences and timers observed by any module in the field.

Control of the module is via push buttons mounted on the front of the module with **Stop/Reset Mode** , **Auto Mode** , **Manual/Start Mode** , **Increase Engine Speed**  and **Decrease Engine Speed**  functions. For normal operation, these are the only controls which need to be operated. Details of their operation are provided later in this document.











## 4.1 CONTROL PUSH BUTTONS

 **NOTE:** For further details, see the section entitled *Operation* elsewhere in this document.



Icon	Description
	<p><b>Stop / Reset Mode</b></p> <p>This button places the module into its <b>Stop/Reset Mode</b> . This clears any alarm conditions for which the triggering criteria have been removed. If the engine is running and the module is put into <b>Stop/Reset Mode</b> , the module automatically instructs the engine to unload (<i>'Clutch Control' becomes inactive (if used)</i>). The fuel supply de-energises and the engine comes to a standstill. Should any form of <i>start signal</i> be present while operating in this mode, a start does <u>not</u> occur.</p> <p>For further details, see the section entitled <i>Operation</i> elsewhere in this document.</p>
	<p><b>Auto Mode</b></p> <p>This button places the module into its <b>Auto Mode</b> . This mode allows the module to control the function of the engine automatically. The module monitors the <i>remote start</i> input and once a start request is made, the set is automatically started.</p> <p>Upon removal of the starting signal, the module removes the load from the engine and shut the set down observing the <i>stop delay</i> timer and <i>cooling</i> timer as necessary. The module then waits for next start event.</p> <p>Also, in <b>Auto Mode</b> , the module responds to the <b>Increase Engine Speed</b>  and <b>Decrease Engine Speed</b>  buttons after the engine's priming stage (if the automatic speed control is configured to <i>'Fixed Speed'</i>). The engine speed can be increased and decreased within the boundaries configured in the module's configuration.</p> <p>For further details, see the section entitled <i>Operation</i> elsewhere in this document.</p>
	<p><b>Manual/Start Mode</b></p> <p>This button places the module into its <b>Manual/Start Mode</b> . Once in <b>Manual/Start Mode</b> , the module starts the engine. The module monitors the engine speed and once the configured value has been met, the engine is automatically placed on load (<i>'Clutch Control' becomes active (if used)</i>). The engine remains on load until <b>Stop/Reset Mode</b>  or <b>Auto Mode</b>  are selected or the engine speed decreases below the configured value.</p> <p>Also, in <b>Manual/Start Mode</b> , the module responds to the <b>Increase Engine Speed</b>  and <b>Decrease Engine Speed</b>  buttons after the engine's priming stage. The engine speed can be increased and decreased within the boundaries configured in the module's configuration.</p> <p>For further details, see the section entitled <i>Operation</i> elsewhere in this document.</p>

 **NOTE:** For further details, see the section entitled *Operation* elsewhere in this document.

Icon	Description
	<p><b>Increase Engine Speed</b></p> <p>This button is only active in the <b>Auto Mode</b>  (if speed control is configured to 'Fixed Speed') or <b>Manual/Start Mode</b> .</p> <p>Pressing the <b>Increase Engine Speed</b>  button increases the engine's speed within the configured boundaries.</p> <p>For further details, see the section entitled <i>Operation</i> elsewhere in this document.</p>
	<p><b>Decrease Engine Speed</b></p> <p>This button is only active in the <b>Auto Mode</b>  (if speed control is configured to 'Fixed Speed') or <b>Manual/Start Mode</b> .</p> <p>Pressing the <b>Decrease Engine Speed</b>  button decreases the engine's speed within the configured boundaries.</p> <p>For further details, see the section entitled <i>Operation</i> elsewhere in this document.</p>
	<p><b>Menu Navigation</b></p> <p>Used for navigating the instrumentation, event log and configuration screens.</p>



## 4.2 VIEWING THE INSTRUMENT PAGES

**NOTE:** Depending upon the module's configuration, some display screens may be disabled. For further details of module configuration, refer to DSE Publication: 057- 251 *DSEE400 Configuration Software Manual*.

It is possible to scroll to display the different pages of information by pressing and holding the **Up**  or **Down**  buttons.

Example

If you want to view one of the instrument pages towards the end of the list, it may be quicker to scroll down through the pages rather than up!

**Status**      Press and Hold **Up**   
**Engine**      Press and Hold **Up**   
**Alarms**      Press and Hold **Up** 

And so on until the desired page is reached. Further presses and holds of the **Up**  button returns the Status page.

The complete order and contents of each information page are given in the following sections.



Once selected, the page remains on the LCD display until the user selects a different page, or after an extended period of inactivity (*LCD Page Timer*), the module reverts to the status display.



If no buttons are pressed upon entering an instrumentation page, the instruments displayed are automatically subject to the setting of the *LCD Scroll Timer*.

The *LCD Page* and *LCD Scroll* timers are configurable using the DSE Configuration Suite Software or by using the Front Panel Editor.



The screenshot shows the factory settings for the timers, taken from the DSE Configuration Suite PC Software.

Alternatively, to scroll manually through all instruments on the currently selected page, press the **Up**  or **Down**  buttons. The 'auto scroll' is disabled.

To re-enable 'auto scroll' press the **Up**  or **Down**  buttons to scroll to the 'title' of the instrumentation page (i.e. Engine). A short time later (the duration of the *LCD Scroll Timer*), the instrumentation display begins to auto scroll.

When scrolling manually, the display automatically returns to the Status page if no buttons are pressed for the duration of the configurable *LCD Page Timer*.

If an alarm becomes active while viewing any page, the display shows the Alarms page to draw the operator's attention to the alarm condition.

### 4.2.1 STATUS



**NOTE:** Press the *Instrumentation Scroll*  buttons on the *Status Page* to view other Configurable Status Screens if configured. For further details of module configuration, refer to DSE Publication: 057- 251 *DSEE400 Configuration Software Manual*.

This is the 'home' page, the page that is displayed when no other page has been selected, and the page that is automatically displayed after a period of inactivity (*LCD Page Timer*) of the module control buttons.

This page changes with the action of the controller for example when the engine is running and available:

<b>Status</b>	<b>22:31</b>	Factory setting of <i>Status</i> screen showing engine stopped...
<b>Engine at Rest</b>		
<b>Stop Mode</b>		

<b>Status</b>	<b>22:31</b>	...and engine running
<b>Engine Speed</b>		
<b>850 RPM</b>		
<b>Tgt 900 RPM</b>		<b>4.50 V</b>

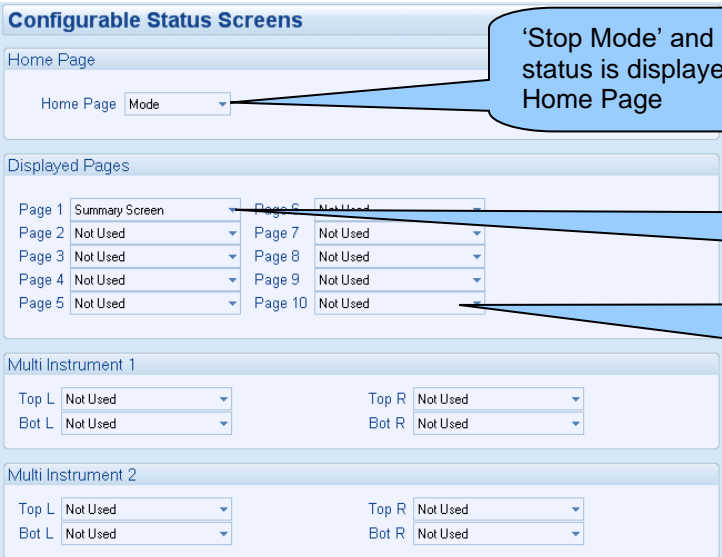

The contents of this display vary depending upon configuration by the engine manufacturer or supplier.

The display above is achieved with the factory settings, shown below in the DSE Configuration suite software:



The screenshot shows the 'Configurable Status Screens' interface. A callout points to the 'Home Page' dropdown menu, stating: "'Stop Mode' and engine status is displayed on the Home Page". Another callout points to the 'Displayed Pages' table, stating: "With a summary of the instrumentation shown when the engine is running." A third callout points to the 'Multi Instrument' sections, stating: "Other pages can be configured to be shown, automatically scrolling when the set is running."

#### 4.2.1.1 ENGINE LOCKED OUT

<b>Status</b>	<b>22:31</b>	<i>Engine Locked Out</i> indicates that the engine cannot be started due to an active <i>Shutdown</i> or <i>Controlled Shutdown Alarm</i> on the module. Press and hold the <b>Up</b>  or <b>Down</b>  buttons to scroll to the alarms page to investigate. Press the <b>Stop/Reset Mode</b> 
<b>Engine Locked Out</b>		

button to clear the alarm if the alarm does not clear the fault is still active.

## 4.2.2 ENGINE

 **NOTE\***: For further details of support engine, refer to DSE Publication: *057-004 Electronic Engines and DSE Wiring Guide*.

These pages contain instrumentation gathered about the engine measured or derived from the module's inputs, some of which may be obtained from the engine ECU.

**Engine**

---









**1500 RPM**

<ul style="list-style-type: none"> <li>Active Configuration</li> <li>Engine Speed</li> <li>Oil Pressure</li> <li>Coolant Temperature</li> <li>Engine Battery Volts</li> <li>Engine Run Time</li> <li>Engine Fuel Level</li> <li>Oil Temperature*</li> <li>Coolant Pressure*</li> <li>Inlet Temperature*</li> <li>Exhaust Temperature*</li> <li>Fuel Temperature*</li> <li>Turbo Pressure*</li> <li>Fuel Pressure*</li> <li>Fuel Consumption*</li> <li>Fuel Used*</li> <li>Flexible Sensors</li> <li>Engine Maintenance Alarm 1</li> <li>Engine Maintenance Alarm 2</li> <li>Engine Maintenance Alarm 3</li> <li>Engine Maintenance Alarm 4</li> <li>Engine Maintenance Alarm 5</li> <li>After Treatment Fuel Used*</li> </ul>	<ul style="list-style-type: none"> <li>After Treatment Exhaust Gas Temperature*</li> <li>Engine Oil Level*</li> <li>Engine Crank Case Pressure*</li> <li>Engine Coolant Level*</li> <li>Engine Injector Rail Pressure*</li> <li>Engine Exhaust Temperature*</li> <li>Intercooler Temperature*</li> <li>Turbo Oil Pressure*</li> <li>Fan Speed*</li> <li>Water In Fuel*</li> <li>Air Inlet Pressure*</li> <li>ECU Regeneration*</li> <li>ECU Regeneration Icons*</li> <li>Engine Soot Levels*</li> <li>DEF Tank Level*</li> <li>DEF Tank Temperature*</li> <li>DEF Reagent Cons*</li> <li>SCR After Treatment Status*</li> <li>ECU ECR DEF Icons*</li> <li>DEF Counter Minimum*</li> <li>DPTC Filter Status*</li> <li>Engine ECU Link*</li> <li>Tier 4 Engine Information*</li> </ul>
---	--

4.2.2.1 DPF REGENERATION LAMPS

**NOTE:** For further details of module configuration, refer to DSE Publication: *057- 251 DSEE400 Configuration Software Manual*.

Depending upon the *Engine Type* selected in the module's configuration, the *Engine* section may include the *DPF Regeneration Lamps* page. This page contains icons to show the status of various ECU functions, some of which are applicable to Tier 4 engine requirements. The icons flash at different rates to show the status of the ECU function, refer to the engine manufacturer for more information about this.

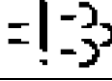
Icon	Fault	Description
	ECU Amber Alarm	The module received an Amber fault condition from the engine ECU.
	ECU Red Alarm	The module received a Red fault condition from the engine ECU.
	DPF Active	The module received a fault indication from the engine ECU informing that the <i>Diesel Particulate Filter</i> is active.
	DPF Inhibited	The module received a fault indication from the engine ECU informing that the <i>Diesel Particulate Filter</i> has been inhibited.
	DPF Stop	The module received a fault indication from the engine ECU informing that the <i>Diesel Particulate Filter</i> has been stopped.
	DPF Warning	The module received a fault condition from the engine ECU informing that the <i>Diesel Particulate Filter</i> has a fault condition.
	HEST Active	The module received a fault indication from the engine ECU informing that the <i>High Exhaust System Temperature</i> is active.
	DEF Low Level	The module received a fault condition from the engine ECU informing that the <i>Diesel Exhaust Fluid Low Level</i> is active.
	SCR Inducement	The module received a fault indication from the engine ECU informing that the <i>Selective Catalytic Reduction Inducement</i> is active.

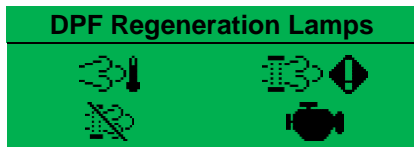

**Example:**



#### 4.2.2.2 MAINTAIN VALUE CONTROL

**NOTE:** Only active when *Maintain Value Control* is enabled. For further details of module configuration, refer to DSE Publication: *057-251 DSEE400 Configuration Software Manual*.

**NOTE:** Configuration for the *Target value Set Point Min / Max* are found within the Modules *Front Panel Editor* in section 7.1 in this manual and *Maintain Value Control* configured within *DSE Configuration Suite PC Software*. For further details of module configuration, refer to DSE Publication: *057-251 DSEE400 Configuration Software Manual*.

Depending upon module configuration, this page allows the user to raise or lower *Target Set Point* of the *Maintain Value Control* parameter by selecting the *Speed Up*  or *Speed Down*  buttons.

**Example:**

Maintain Value Control	
Value	1.50 bar
Target	2.50 bar



The value read from the configured Flexible Sensor to be maintained

The Target Set Point value that the engine attempts to maintain the flexible sensor value at.

### 4.2.3 ALARMS

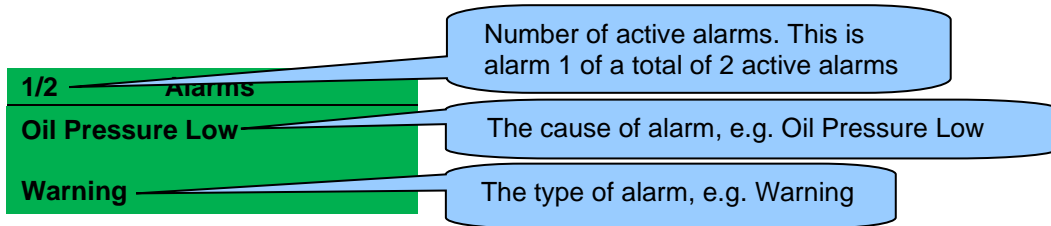
When an alarm is active, the LCD display jumps to display the *Alarms Page*.



The LCD displays multiple alarms such as “Coolant Temp High”, “Emergency Stop” and “Low Coolant Warning”. These automatically scroll in the order that they occurred or press the **Up**  or **Down**  buttons scroll through manually.

In the event of an alarm, the LCD displays the appropriate text. If an additional alarm then occurs, the module displays the appropriate text.

**Example:**

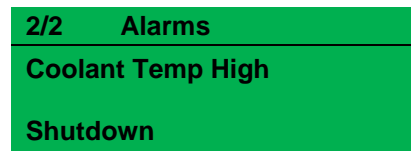
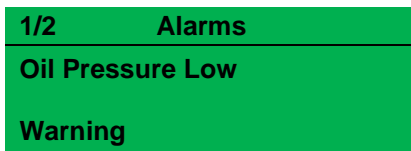



#### 4.2.3.1 ECU ALARMS (CAN FAULT CODES / DTC)

 **NOTE:** For details on these code/graphic meanings, refer to the ECU instructions provided by the engine manufacturer, or contact the engine manufacturer for further assistance.

 **NOTE:** For further details on connection to electronic engines, refer to DSE Publication: *057-004 Electronic Engines and DSE Wiring*

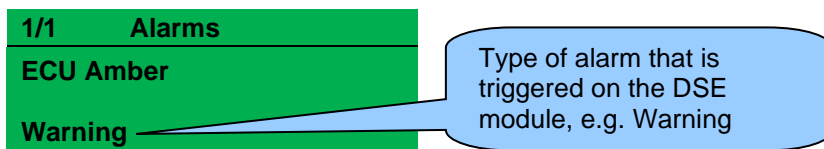
When connected to a suitable CAN engine, the controller displays alarm status messages from the ECU in the *Alarms* section of the display.



Press and hold the **Up**  button to access the list of *Engine DTCs* (Diagnostic Trouble Codes) from the ECU which are DM1 messages.

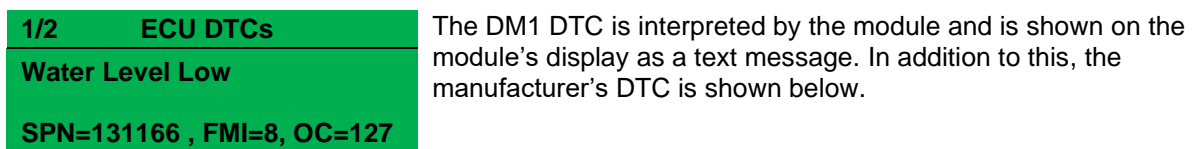

#### 4.2.4 EVENT LOG



**NOTE:** For further details of module configuration, refer to DSE Publication: *057- 251 DSEE400 Configuration Software Manual*.

The module maintains a log of past alarms and/or selected status changes. At the time of writing, the modules log can store the last 250 log entries.

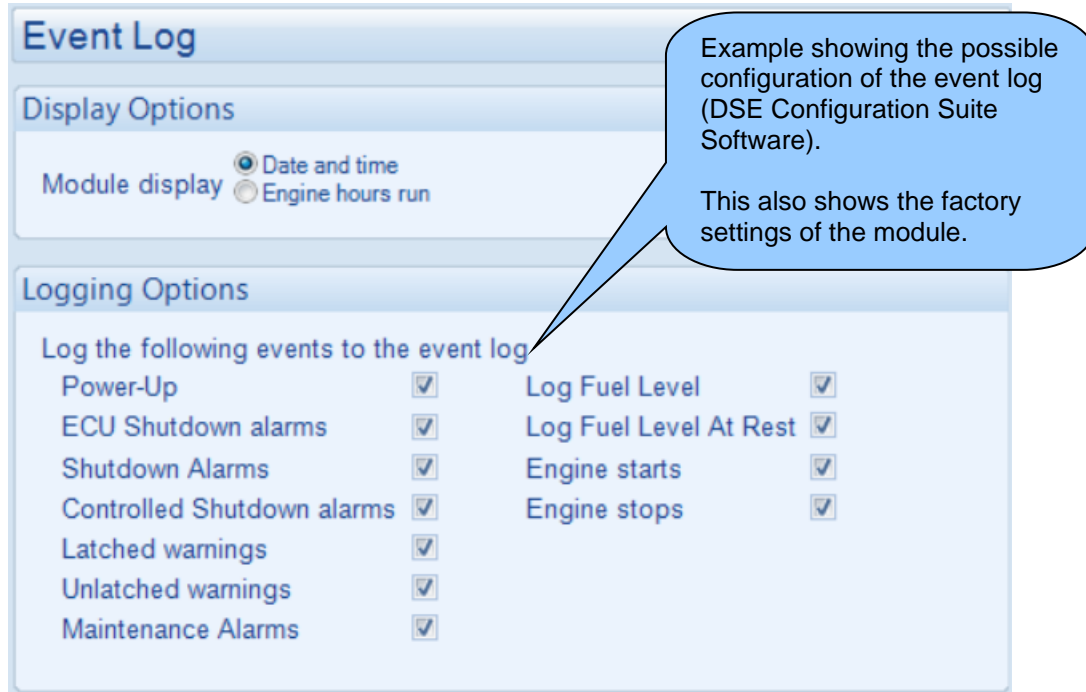
Under default factory settings, the event log is configured to include all possible options; however, this is configurable by the system designer using the DSE Configuration Suite software.



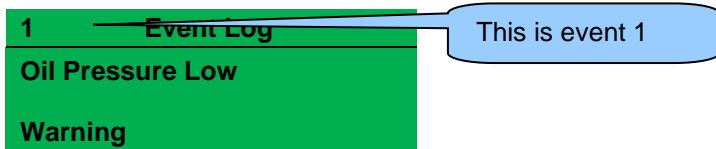

When the event log is full, any subsequent event overwrites the oldest entry. Hence, the event log always contains the most recent events. The module logs the event type, along with the date and time (or engine running hours if configured to do so).

To view the event log, repeatedly press and hold the **Up**  or **Down**  buttons until the LCD screen displays the *Event Log* page.



Press the **Down**  button to view the next most recent event.

Continuing to press the **Down**  button cycles through the past events after which, the display shows the most recent alarm, and the cycle begins again.

To exit the event log and return to viewing the instruments, press and hold the **Up**  or **Down**  buttons to select the next instrumentation page.

#### 4.2.5 SERIAL PORT

This section is included to give information about the RS485 serial port.

The items displayed on this page change depending upon configuration of the module. Refer to the system supplier for further details.

**NOTE: Factory Default settings are for the RS485 port to operate at 19200 baud, MODBUS slave address 10.**

##### Connected to an R485 MODBUS Client

The modules operate as a MODBUS RTU slave device. In a MODBUS system, there is only one client, typically a PLC, HMI system or PC SCADA system.

Serial Port	
Baud	19200
Server ID	10

This client requests for information from the MODBUS server (The module) and may (in control systems) also send request to change operating modes etc. Unless the client makes a request, the server is 'quiet' on the data link.

The factory settings are for the module to communicate at 19200 baud, MODBUS slave address 10.

The screenshot shows the 'RS485 Port' configuration window. Under the 'Basic' tab, the 'Server ID' is set to 10, 'Baud Rate' is set to 19200, and 'Port Usage' is set to 'Modbus Server'. Under the 'Advanced' tab, the 'Client inactivity timeout' is set to 5s, indicated by a slider control.

'Client inactivity timeout' should be set to at least twice the value of the system scan time. For example, if a MODBUS client PLC requests data from the module once per second, the timeout should be set to at least 2 seconds.

The DSE MODBUS document containing register mappings inside the DSE module is available upon request from support@deepseapl.com. Email the request along with the serial number of the DSE module to ensure the correct information is sent.

##### Typical Requests (Using Pseudo Code)

**BatteryVoltage=ReadRegister(10,0405,1):** reads register (hex) 0405 as a single register (battery volts) from slave address 10.

**WriteRegister(10,1008,2,35701, 65535-35701):** Puts the module into AUTO mode by writing to (hex) register 1008, the values 35701 (auto mode) and register 1009 the value 65535-35701 (the bitwise opposite of auto mode)

**Warning=(ReadRegister(10,0306,1) >> 11) & 1:** reads (hex) 0306 and looks at bit 12 (Warning alarm present)

**ControlledShutdown=(ReadRegister(10,0306,1) >> 10) & 1:** reads (hex) 0306 and looks at bit 11 (Controlled Shutdown alarm present)

**ControlMode=ReadRegister(10,0304,2):** reads (hex) register 0304 (control mode).

#### 4.2.6 ABOUT

Contains important information about the module and the firmware versions. This information may be asked for when contacting DSE Technical Support Department for advice.

About	
Variant	E400
Application	V1.0.12
USB ID	BC614E

**Variant:** E400  
**Application Version:** The version of the module's main firmware file (Updatable using the Firmware Update Wizard in the DSE Configuration Suite Software).  
**USB ID:** Unique identifier for PC USB connection

Press the **Down**  button to access more information about the module.

About	
Bootloader	V2.0.3

**Bootloader:** Firmware Update bootloader software version.

About	
Engine Type	Volvo EMS2b
Version	V1.21

**Engine Type:** The name of the engine file selected in the configuration  
**Version:** Engine type file version.

About	
LCD Temperature	20 °C 68 °F

**LCD Temperature:** The current operating temperature of the module's LCD display.

#### 4.2.7 PLC INSTRUMENTS

**NOTE:** PLC Instrument page is only available on hardware version E400-002-## or above. Only PLC watched timers, counters and persistent variables may be edited

**NOTE:** Depending upon the module's configuration, some display screens may be disabled. For further details of module configuration, refer to DSE Publication: 057-251 *DSE400 Configuration Suite PC Software Manual* and 057-314 *Advanced PLC Programming Guide for DSE Controllers*.

Contains values from various elements from the module's internal PLC editor to enable the user to view and edit them from the module's fascia.

- Press and hold the **Up**  or **Down**  buttons to cycle to the section to view/change.

**Counter Example:**

PLC Instruments	
New Counter 1	5

**Counter 1:** The name of the Counter as configured in the PLC.  
**Value:** The value the Counter currently contains.

**Persistent Variable Example:**

PLC Instruments	
New Persistent Var 1	127

**Persistent Variable:** The name of the Persistent Variable as configured in the PLC.  
**Value:** The value the Persistent Variable currently contains.

**String Example:**

PLC Instruments	
New String Var 1	Test

**String:** The name of the string as configured in the PLC.

**Timer Example:**

PLC Instruments	
New Timer 1	00:00:02.5

**Timer 1:** The name of the timer as configured in the PLC.  
**Value:** The time configured in the PLC.

**Variable Example:**

PLC Instruments	
New Variable 1	58

**Variable:** The name of the Variable as configured in the PLC.  
**Value:** The value the Variable currently contains.

Delay On Timer Example:

PLC Instruments	
TON – 1	
Actual	00:14:07
Set Point	00:50:30

**TON – 1:** The name of the Delay On Timer as configured in the PLC.  
**Actual:** The time the timer has currently reached.  
**Set Point:** The time at which the timer stops incrementing

Delay Off Timer Example:

PLC Instruments	
TOF – 2	
Actual	00:17:01
Set Point	00:41:30

**TOF – 2:** The name of the Delay Off Timer as configured in the PLC.  
**Actual:** The time the timer has currently reached.  
**Set Point:** The time at which the timer stops incrementing

Counter Example:

PLC Instruments	
Counter 1	
Actual	5
Set Point	15

**Counter 1:** The name of the counter as configured in the PLC.  
**Actual:** The number the counter has currently reached.  
**Set Point:** The number at which the counter stops incrementing

### 4.2.8 CHARGER

These pages contain instrumentation gathered about the charger connected to the DSEE400 module via the RS485 Port.

#### Charger Information

Charger 0	
Device	9470
	V7.3.0
USB ID	12A1F5779

Information screen of the charger connected to the DSE module (battery charger model number, version, and its USB ID).

#### Supply Voltage

Supply Voltage	
L1-N	244v

Supply Instrumentation Screen.

#### Supply Frequency

Supply Frequency	
Frequency	50.4 Hz

Battery charger supply frequency instrumentation screen.

#### Temperature

Supply Voltage	
Temperature	32 °C
	89 °F

Battery charger temperature instrumentation screen.

#### Charger Output

Charger Output 1	
Output State	On
Charge Mode	PSU Mode
Fault State	None

Output Instrumentation screen. Showing Output 1 of the battery charger and the charge mode (Boost, Absorption, Float, Storage or PSU).

Charger Output 1	
Output	11.95 v

Showing the output voltage

Charger Output continued....

Charger Output 1	
Current	0.00 A
Limit	1.00 A
Power	0 W

Showing the output current, limit, and power.

Charger Output 1	
Batt Temp	0 °C
	32 °F

Battery temperature instrumentation screen.

## 5 OPERATION

**NOTE:** The following descriptions detail the sequences followed by a module containing the standard 'factory configuration'. Always refer to your configuration source for the exact sequences and timers observed by any module in the field.

### 5.1 QUICKSTART GUIDE

This section provides a quick start guide to the module's operation.

#### 5.1.1 STARTING THE ENGINE

**NOTE:** For further details, see the section entitled *Operation* elsewhere in this document.



### 5.1.2 STOPPING THE ENGINE

**NOTE:** For further details, see the section entitled *Operation* elsewhere in this document.





## 5.2 STOP/RESET MODE

**NOTE:** If a digital input configured to *Panel Lock* is active, changing module modes is not possible. Viewing the instruments and event logs is NOT affected by *Panel Lock*.

**NOTE:** For further details of module configuration, refer to DSE Publication: *057- 251 DSEE400 Configuration Suite Software Manual*.

**Stop/Reset Mode** is activated by pressing the **Stop/Reset Mode**  button.

The LED above the **Stop/Reset Mode**  button illuminates to indicate **Stop/Reset Mode**  operation.

In **Stop/Reset Mode** , the module removes the engine from load (if necessary) before stopping the engine.

If the engine does not stop when requested, the *Fail To Stop* alarm is activated (subject to the setting of the *Fail to Stop* timer). To detect the engine at rest the following must occur:

- Engine speed is zero as detected by the CAN ECU or Magnetic Pickup input
- Engine Charge Alternator Voltage must be zero.
- Oil pressure sensor must indicate low oil pressure

When the engine has stopped and the module is in the **Stop/Reset Mode** , it is possible to send configuration files to the module from DSE Configuration Suite PC software and to enter the Front Panel Editor to change parameters.

Any latched alarms are reset when **Stop/Reset Mode**  is entered if the fault has been cleared

The engine is not started when in **Stop/Reset Mode** . If start signals are given, the input is ignored until **Auto Mode**  is entered.

When left in **Stop/Reset Mode**  with no presses of the fascia buttons, no form of communication active and configured for *Power Save Mode*, the module enters *Power Save Mode*. To 'wake' the module, press any fascia control buttons.

Power Save Mode  
in the DSE  
Configuration Suite

Power Save Mode Enable





### 5.2.1 ECU OVERRIDE

 **NOTE:** *Protected Start Mode must be enabled to activate this feature, refer to DSE Publication: 057-251 DSEE400 Configuration Suite Software Manual.*

Pressing the **Start**  button in **Stop/Reset Mode**  powers up the engine's ECU but does not start the engine. This is used to check the status of the CAN communication and to prime the fuel system.

When an ECU override is active, the module displays "ECU override" on the status screen, the ECU override timer begins, and the start LED flashes to indicate the module is armed and ready to start the engine on the next **Start**  button press.

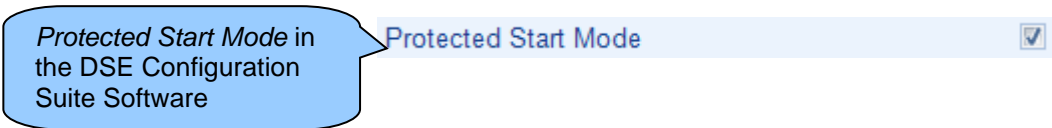

ECU override remains active until a start command is issued, the timer has lapsed, **Auto Mode**  is entered and a scheduled start becomes active or **Auto Mode**  is entered and an auto start state becomes active.



## 5.3 AUTOMATIC MODE

**NOTE:** If a digital input configured to external *Panel Pock* is active, changing module modes is not possible. Viewing the instruments and event logs is NOT affected by *Panel Lock*.

**Auto Mode** is activated by pressing the **Auto Mode**  button.

The LED above the **Auto Mode**  button illuminates to indicate **Auto Mode**  operations.

**Auto Mode**  allows the engine to operate fully automatically, starting and stopping as required with no user intervention.

### 5.3.1 WAITING IN AUTO MODE

If a starting request is made, the starting sequence begins. Starting requests can be from the following sources:

- Activation of a digital input that has been configured to *Remote Start*.
- Activation of an analogue sensor reaching a certain configured value.
- Activation of the inbuilt exercise scheduler.
- Instruction from external remote telemetry devices using the RS485 interface.

### 5.3.2 STARTING SEQUENCE

**NOTE:** If the unit has been configured for CAN, compatible ECU's receive the start command via CAN and transmit the engine speed to the DSE controller.

**NOTE:** For further details of module configuration, refer to DSE Publication: *057- 251 DSEE400 Configuration Software Manual*.

To allow for 'false' start requests, the *Start Delay* timer begins.

Should all start requests be removed during the *Start Delay* timer, the unit returns to a stand-by state.

If a start request is still present at the end of the *Start Delay* timer, the fuel relay is energised, and the engine is cranked.

If the engine fails to fire during this cranking attempt, then the starter motor is disengaged for the *Crank Rest* duration after which the next start attempt is made. Should this sequence continue beyond the *Set Number Of Attempts*, the start sequence is terminated, and the display shows *Fail to Start*.

The starter motor is disengaged when the engine fires. Speed detection is factory configured to be measured from a Magnetic Pickup mounted on the flywheel but can additionally be configured to be measured from the CAN link to the engine ECU.

Additionally, rising oil pressure or engine charge alternator voltage can be used to disconnect the starter motor (but cannot detect under speed or overspeed).

After the starter motor has disengaged, the *Safety On Delay* timer activates, allowing Oil Pressure, High Engine Temperature, Under-speed, Charge Fail and any delayed Auxiliary fault inputs to stabilise without triggering the fault.

### 5.3.3 ENGINE RUNNING

 **NOTE: The *Clutch Control Output* signal remains inactive until the engine is available. This prevents excessive wear on the engine.**

Once the engine is running and all starting timers have expired, the engine is seen as available.

The ***Clutch Control*** output (if configured) activates automatically.

If all start requests are removed, the *Stopping Sequence* begins.

When *Speed Control in Auto* is set to *Manual*; refer to the section entitled *Manual Speed Control* elsewhere in this document.

### 5.3.4 STOPPING SEQUENCE

The *Return Delay* timer operates to ensure that the starting request has been permanently removed and is not just a short-term removal. Should another start request be made during the cooling down period, the set returns on load.

If there are no starting requests at the end of the *Return Delay* timer, the ***Clutch Control*** output (if configured) de-activates and the *Cooling Down Timer* is initiated.



The *Cooling Down Timer* allows the engine to run off load and cool sufficiently before being stopped. This is particularly important where turbo chargers are fitted.

After the *Cooling Down* timer has expired, the set is stopped.

## 5.4 MANUAL/START MODE

 **NOTE:** If a digital input configured to Panel Lock is active, changing module modes is not possible. Viewing the instruments and event logs is NOT affected by panel lock.

**Manual/Start Mode** is activated by pressing the **Manual/Start Mode**  button.

The LED above the **Manual/Start Mode**  button illuminates to indicate **Manual/Start Mode**  operations.

### 5.4.1 STARTING SEQUENCE

 **NOTE:** There is no *Start Delay* in this mode of operation.

 **NOTE:** If the unit has been configured for CAN, compatible ECU's receives the start command via CAN.

 **NOTE:** For further details of module configuration, refer to DSE Publication: *057- 251 DSEE400 Configuration Software Manual*.

If no preheat timer is configured, the fuel relay is energised as soon as the **Manual/Start Mode**  button is pressed, and the engine is cranked.

If the engine fails to fire during this cranking attempt, then the starter motor is disengaged for the *Crank Rest* duration after which the next start attempt is made. Should this sequence continue beyond the *Set Number Of Attempts*, the start sequence is terminated, and the display shows *Fail to Start*.

The starter motor is disengaged when the engine fires. Speed detection is factory configured to be measured from a Magnetic Pickup mounted on the flywheel but can additionally be configured to be measured from the CAN link to the engine ECU.

Additionally, rising oil pressure or engine charge alternator voltage can be used to disconnect the starter motor (but cannot detect under speed or overspeed).

After the starter motor has disengaged, the *Safety On Delay* timer activates, allowing Oil Pressure, High Engine Temperature, Under-speed, Charge Fail and any delayed Auxiliary fault inputs to stabilise without triggering the fault.



## 5.4.2 ENGINE RUNNING

 **NOTE:** The *Clutch Control* remains inactive until the Oil Pressure has risen. This prevents excessive wear on the engine.



Once the engine is running and all starting timers have expired, the engine is seen as available.



In **Manual/Start Mode** , the **Clutch Control** output (if configured) activates automatically if the engine speed has increased above the configured engage value.

Once the engine has been placed on load, it is not automatically removed. To manually remove the load either:



- Press the **Auto Mode**  button to return to automatic mode. The set observes all **Auto Mode**  start requests and stopping timers before beginning the *Auto Mode Stopping Sequence*.
- Press the **Stop/Reset Mode**  button to remove load and stop the engine.



## 5.4.3 MANUAL SPEED CONTROL

Once the engine is running and available, the engine speed is adjustable between the configured *Min Speed* and *Max Speed* range. Press the **Increase Engine Speed**  button to increase the engine's speed within the configured range, the speed increases by the amount of the configured *Step Size* in rpm. When ramping is enabled, holding the **Increase Engine Speed**  button causes the speed to raise according to the ramp rate setting rather than the step size setting.

Press the **Decrease Engine Speed**  button to decrease the engine's speed within the configured range, the speed decreases by the amount of the configured *Step Size* in rpm. When ramping is enabled, holding the **Decrease Engine Speed**  button causes the speed to lower according to the ramp rate setting rather than the step size setting.

## 5.4.4 MANUAL RUN TIME



When the engine is running in **Manual/Start Mode**, pressing the **Manual/Start Mode**  button a second time initiates the *Run Timer*, the module runs the set for the configured *Run Timer* amount of time before initiating the *Stopping Sequence*. Another press on the **Manual/Start Mode**  button deactivates the *Run Timer*, and the engine continues running in **Manual Mode**.

While the set is operating in *Manual Run Time*, the **Increase Engine Speed**  button and **Decrease Engine Speed**  buttons are used to increment and decrement the amount of the *Run Timer*.

## 5.4.5 STOPPING SEQUENCE

In **Manual/Start Mode**  the set continues to run until either:

The **Stop/Reset Mode**  button is pressed – The **Clutch Control** output is de-activated immediately and the engine immediately stops.

- The **Auto Mode**  button is pressed. The set observes all **Auto Mode**  start requests and stopping timers before beginning the *Auto Mode Stopping Sequence*

## 5.5 SCHEDULER

The controller contains an inbuilt exercise run scheduler, capable of automatically starting and stopping the set or inhibiting the set from starting. Up to 8 scheduled start/stop/inhibiting start sequences can be configured to repeat on a 7-day or monthly cycle.

Scheduled runs may be on load or off load depending upon module configuration.

### Example:

Screen capture from DSE Configuration Suite Software showing the configuration of the Exercise Scheduler.





In this example the set starts at 09:00 on Monday and run for 5 hours off load, then start at 13:30 on Tuesday and run for 30 minutes on load and is inhibited from automatically starting on Monday from 17:00 for 12 hours.

Week	Day	Run Mode	Start Time	Duration	Clear
	Monday	Off Load	09:00	05:00	Clear
	Tuesday	On Load	13:30	00:30	Clear
	Monday	Auto Start Inhibit	17:00	12:00	Clear
	Monday	Off Load	00:00	00:00	Clear
	Monday	Off Load	00:00	00:00	Clear
	Monday	Off Load	00:00	00:00	Clear
	Monday	Off Load	00:00	00:00	Clear
	Monday	Off Load	00:00	00:00	Clear



### 5.5.1 STOP MODE

- Scheduled runs do not occur when the module is in **Stop/Reset Mode** .

### 5.5.2 AUTO MODE

- Scheduled runs operate only if the module is in **Auto Mode**  with no *Shutdown* or *Controlled Shutdown* alarm active.
- If the module is in **Stop/Reset Mode**  or **Manual/Start Mode**  when a scheduled run begins, the engine is not started. However, if the module is moved into **Auto Mode**  during a scheduled run, the engine is called to start.
- Depending upon configuration by the system designer, an external input can be used to inhibit a scheduled run.
- If the engine is running *Off Load* in **Auto Mode**  and a scheduled run configured to 'On Load' begins, the set is placed *On Load* for the duration of the Schedule.

### 5.5.3 MANUAL/START MODE



- Scheduled runs do not occur when the module is in **Manual/Start Mode**  waiting for a start request.
- Activation of a Scheduled Run 'On Load' when the module is operating *Off Load* in **Manual/Start Mode**  forces the set to run *On Load*.

## 6 PROTECTIONS

### 6.1 ALARMS

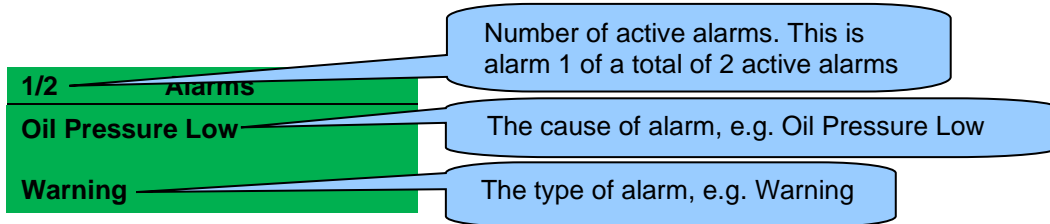
When an alarm is active, the LCD display jumps to display the *Alarms Page*.



The LCD displays multiple alarms such as “*Coolant Temp High*”, “*Emergency Stop*” and “*Low Coolant Warning*”. These automatically scroll in the order that they occurred or press the **Up**  or **Down**  buttons scroll through manually.

In the event of an alarm, the LCD displays the appropriate text. If an additional alarm then occurs, the module displays the appropriate text.

**Example:**

1/2	Alarms
Oil Pressure Low	
Warning	

2/2	Alarms
Coolant Temp High	
Shutdown	

### 6.1.1 PROTECTIONS DISABLED

**NOTE:** For further details of module configuration, refer to DSE Publication: *057-251 DSEE400 Configuration Software Manual*.

User configuration is possible to prevent *Shutdown* and *Controlled Shutdown* alarms from stopping the engine. Under such conditions, *Protections Disabled* appears on the module display to inform the operator. *Shutdown* and *Controlled Shutdown* alarms still appear however, the operator is informed the alarms are blocked.

**Example:**

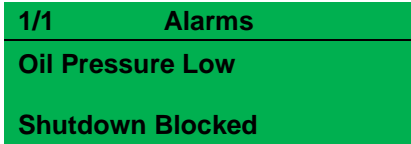

This feature is provided to assist the system designer in meeting specifications for *Warning Only*, *Protections Disabled*, *Run to Destruction*, *War Mode*, or other similar wording.

When configuring this feature in the PC software, the system designer chooses to make the feature permanently active or only active upon operation of an external switch. The system designer provides this switch (not DSE), so its location varies depending upon manufacturer, however it normally takes the form of a key operated switch to prevent inadvertent activation. Depending upon configuration, a warning alarm may be generated when the switch is operated.

The feature is configurable in the PC configuration software for the module. Writing a configuration to the controller that has "Protections Disabled" configured, results in a warning message appearing on the PC screen for the user to acknowledge before the controller's configuration is changed. This prevents inadvertent activation of the feature.

#### 6.1.1.1 INDICATION AND WARNING ALARMS

During an Indication or Warning alarm:

- The module operation is unaffected by the *Protections Disabled* feature. See the sections entitled *Indications* and *Warning Alarms* elsewhere in this document.

### 6.1.1.2 SHUTDOWN AND CONTROLLED SHUTDOWN ALARMS

**NOTE:** The Emergency Stop input and Engine Overspeed Shutdown alarms continue to operate even when *Protections Disabled* is activated.

During a Shutdown or Controlled Shutdown alarm conditions (excluding Emergency Stop and Overspeed):

- The alarm is displayed on the screen as detailed in the sections entitled *Controlled Shutdown Alarms or Shutdown Alarms* elsewhere in this document.
- The set continues to run.
- The *Clutch Control* output stays active
- **Shutdown Blocked** also appears on the LCD screen to inform the operator that the *Protections Disabled* feature has blocked the shutdown of the engine under the normally critical fault.
- The alarm is logged by the controllers *Event Log* (if configured to log that type of alarm) and logs that the shutdown was prevented.

### 6.1.2 ECU ALARMS (CAN FAULT CODES / DTC)

**NOTE:** For details on these code/graphic meanings, refer to the ECU instructions provided by the engine manufacturer, or contact the engine manufacturer for further assistance.

**NOTE:** For further details on connection to electronic engines, refer to DSE Publication: *057-004 Electronic Engines And DSE Wiring*

When connected to a suitable CAN engine, the controller displays alarm status messages from the ECU in the *Alarms* section of the display.

1/1	Alarms
ECU Amber	Warning

Type of alarm that is triggered on the DSE module, e.g. Warning

Press and hold the **Up** button to access the list of *Engine DTCs* (Diagnostic Trouble Codes) from the ECU which are DM1 messages.

1/2	ECU DTCs
Water Level Low	SPN=131166 , FMI=8, OC=127

The DM1 DTC is interpreted by the module and is shown on the module's display as a text message. In addition to this, the manufacturer's DTC is shown below.

## 6.2 INDICATIONS

Indications are non-critical and often status conditions. They do not appear on the LCD display of the module as a text message in the *Status*, *Event Log* or *Alarms* pages. However, an output indicator is configured to draw the operator's attention to the event.

### Example:

- Input configured for indication.
- The LCD text does not appear on the module display but can be added in the configuration to remind the system designer what the input is used for.
- As the input is configured to *Indication* there is no alarm generated.
- Output activates when Digital Input A is active.

The image shows two configuration panels. The top panel, titled "Digital Input A", has the following settings: Function is "User Configured", Polarity is "Open to Activate", Action is "Indication", Arming is "Always", LCD Display is "Panel Door Open", and Activation Delay is "0s". The bottom panel, titled "Relay Outputs", shows Output C with Source set to "Digital Input A" and Polarity set to "Energise".

Digital Input A	
Function	User Configured
Polarity	Open to Activate
Action	Indication
Arming	Always
LCD Display	Panel Door Open
Activation Delay	0s

Relay Outputs		
	Source	Polarity
Output C	Digital Input A	Energise

### 6.3 WARNING ALARMS

Warnings are non-critical alarm conditions and do not affect the operation of the engine system, they serve to draw the operator's attention to an undesirable condition.

Example:

1/2	Alarms
Coolant Temp High	
Warning	

In the event of an alarm the LCD jumps to the alarms page and scroll through all active alarms.

By default, warning alarms are self-resetting when the fault condition is removed. However, enabling *All Warnings Are Latched* causes warning alarms to latch until reset manually. This is enabled using the DSE Configuration Suite in conjunction with a compatible PC.

If the module is configured for **CAN** and receives an "error" message from the ECU, "ECU Warning" is shown on the module's display as a warning alarm.

Fault	Description
Analogue Input A to G (Digital)	<div style="border: 1px solid black; padding: 5px;">  <b>NOTE: Due to module configuration the alarm message that appears on the display may be different. For further details of module configuration, refer to DSE Publication: 057- 251 DSEE400 Configuration Software Manual.</b> </div> <p>The module detected that an analogue input configured as a digital input to create a fault condition became active and the appropriate LCD message is displayed.</p>
Calibration Fault	The module detected that its internal calibration has failed. The unit must be sent back to DSE to be investigated and repaired. Contact DSE Technical Support for more details.
Charge Alt Failure IEEE 37.2 – 27 DC Undervoltage Relay	The module detected that the output voltage of the charge alternator had fallen below the <i>Charge Alternator Warning Trip</i> level for the configured delay timer.
Coolant Temp High IEEE C37.2 – 26 Apparatus Thermal Device	The module detected that the engine coolant temperature had risen above the <i>High Coolant Temperature Pre-Alarm Trip</i> level after the <i>Safety On Delay</i> timer had expired.
DC Battery High Voltage IEEE 37.2 – 59 DC Overvoltage Relay	The module detected that its DC supply voltage had risen above the <i>Plant Battery Overvolts Warning Trip</i> level for the configured delay timer.
DC Battery Low Voltage IEEE 37.2 – 27 DC Undervoltage Relay	The module detected that its DC supply voltage had fallen below the <i>Plant Battery Undervolts Warning Trip</i> level for the configured delay timer.
DEF Level Low	The module received a fault condition from the engine ECU alerting about the DEF level.

Continued over page...

Fault	Description
Digital Input A to D	<p><b>▲ NOTE: Due to module configuration the alarm message that appears on the display may be different. For further details of module configuration, refer to DSE Publication: 057- 251 DSEE400 Configuration Software Manual.</b></p> <p>The module detected that a digital input configured to create a fault condition became active and the appropriate LCD message is displayed.</p>
DPTC Filter	The module received a fault condition from the engine ECU alerting that the DPF/DPTC had activated.
ECU Amber	The module received an amber fault condition from the engine ECU.
ECU Data Fail	The module is configured for CAN operation but has not detected data being sent from the engine's ECU.
ECU Malfunc.	The module received a malfunction fault condition from the engine ECU.
ECU Protect	The module received a protect fault condition from the engine ECU.
ECU Red	The module received a red fault condition from the engine ECU.
Engine Over Speed IEEE C37.2 - 12 Overspeed Device	The module detected that the engine speed had risen above the <i>Over Speed Pre-Alarm Trip</i> level for the configured delay timer.
Engine Over Speed Delayed IEEE C37.2 - 12 Overspeed Device	The module detected that the engine speed had risen above the <i>Over Speed Trip</i> level but was below the <i>Over Speed Overshoot Trip</i> for the configured <i>Overshoot Delay</i> timer during starting.
Engine Under Speed IEEE C37.2 - 14 Underspeed Device	The module detected that the engine speed had fallen below the <i>Under Speed Pre-Alarm Trip</i> level for the configured delay timer after the <i>Safety On Delay</i> timer had expired.
Flexible Sensor A to G High	<p><b>▲ NOTE: Due to module configuration the alarm message that appears on the display may be different. For further details of module configuration, refer to DSE Publication: 057- 251 DSEE400 Configuration Software Manual.</b></p> <p>The module detected that an analogue input value had risen above the <i>Flexible Sensor High Pre-Alarm Trip</i> level.</p>
Flexible Sensor A to G Low	<p><b>▲ NOTE: Due to module configuration the alarm message that appears on the display may be different. For further details of module configuration, refer to DSE Publication: 057- 251 DSEE400 Configuration Software Manual.</b></p> <p>The module detected that an analogue input value had fallen below the <i>Flexible Sensor Low Pre-Alarm Trip</i> level.</p>
Fuel Level Low IEEE C37.2 - 71 Liquid Level Switch	The module detected that the engine fuel level had fallen below the <i>Low Fuel Level Trip</i> level.
Fuel Level Low Switch IEEE C37.2 - 71 Liquid Level Switch	The module detected that the engine low fuel level switch had activated.
Fuel Usage IEEE C37.2 - 80 Flow Switch	The module detected that the fuel consumption was more than the configured <i>Running Rate</i> or <i>Stopped Rate</i> .
HEST Active	The module received a fault condition from the engine ECU alerting that the HEST had activated.
Loss of Mag-PU	The module detected that the magnetic pick up was not producing a pulse output after the required <i>Crank Disconnect</i> criteria had been met.
Low Coolant Warning	The module detected that the engine coolant temperature had fallen below the <i>Low Coolant Temperature Pre-Alarm Trip</i> level.

Continued over page...

Protections

Fault	Description
Maintenance Due	<p><b>▲ NOTE: Due to module configuration the alarm message that appears on the display may be different. For further details of module configuration, refer to DSE Publication: 057- 251 DSEE400 Configuration Software Manual.</b></p> <p>The module detected that one of the configured maintenance alarms is due as its configured maintenance interval has expired.</p>
Oil Pressure Low IEEE C37.2 - 63 Pressure Switch	The module detected that the engine oil pressure had fallen below the <i>Low Oil Pressure Pre-Alarm Trip</i> level after the <i>Safety On Delay</i> timer had expired.
Protections Disabled	The module detected that an input configured for Protections Disable became active.
SCR Inducement	The module received a fault condition from the engine ECU alerting about the SCR Inducement.
Water in Fuel	The module received a fault condition from the engine ECU alerting that water in the fuel had been detected.

## 6.4 CONTROLLED SHUTDOWN ALARMS

 **NOTE:** Shutdown and Controlled Shutdown alarms can be disabled by user configuration. See the section entitled *Protections Disabled* elsewhere in this document.

 **NOTE:** The fault condition must be resolved before the alarm can be reset. If the fault condition remains, it is not possible to reset the alarm (the exception to this is the *Coolant Temp High* alarm and similar *Active From Safety On* alarms, as the coolant temperature could be high with the engine at rest).

Controlled Shutdown Alarms are latching and stop the engine but in a controlled manner. On initiation of the controlled shutdown condition the module de-activates the **Clutch Control Output** to remove the load from the engine. Once this has occurred the module starts the *Cooling Timer* and allows the engine to cool off-load before shutting down it down. To restart the engine the fault must be cleared, and the alarm reset.

**Example:**

1/2 Alarms
Coolant Temp High
Controlled Shutdown

In the event of an alarm the LCD jumps to the alarms page and scrolls through all active alarms.

Controlled Shutdown Alarms are latching alarms and to remove the fault, press the **Stop/Reset Mode**  button on the module.

Fault	Description
Analogue Input A to G (Digital)	<div style="border: 1px solid black; padding: 5px; margin-bottom: 5px;">  <b>NOTE:</b> Due to module configuration the alarm message that appears on the display may be different. For further details of module configuration, refer to DSE Publication: 057- 251 DSEE400 Configuration Software Manual.                 </div> <p>The module detected that an analogue input configured as a digital input to create a fault condition became active and the appropriate LCD message is displayed.</p>
Calibration Fault	The module detected that its internal calibration has failed. The unit must be sent back to DSE to be investigated and repaired. Contact DSE Technical Support for more details.
Coolant Temp High <small>IEEE C37.2 – 26 Apparatus Thermal Device</small>	The module detected that the engine coolant temperature had risen above the <i>High Coolant Temperature Controlled Shutdown</i> level after the <i>Safety On Delay</i> timer had expired.
DEF Level Low	The module received a fault condition from the engine ECU alerting about the DEF level.

Continued over page...

Fault	Description
Digital Input A to D	<p><b>▲ NOTE: Due to module configuration the alarm message that appears on the display may be different. For further details of module configuration, refer to DSE Publication: 057- 251 DSEE400 Configuration Software Manual.</b></p> <p>The module detected that a digital input configured to create a fault condition became active and the appropriate LCD message is displayed.</p>
DPTC Filter	The module received a fault condition from the engine ECU alerting that the DPF/DPTC had activated.
ECU Amber	The module received an amber fault condition from the engine ECU.
ECU Data Fail	The module is configured for CAN operation but has not detected data being sent from the engine's ECU.
ECU Malfunc.	The module received a malfunction fault condition from the engine ECU.
ECU Protect	The module received a protect fault condition from the engine ECU.
ECU Red	The module received a red fault condition from the engine ECU.
Flexible Sensor A to G Fault	<p><b>▲ NOTE: Due to module configuration the alarm message that appears on the display may be different. For further details of module configuration, refer to DSE Publication: 057- 251 DSEE400 Configuration Software Manual.</b></p> <p>The module detected that circuit to the flexible sensor had become open circuit.</p>
Flexible Sensor A to G High	<p><b>▲ NOTE: Due to module configuration the alarm message that appears on the display may be different. For further details of module configuration, refer to DSE Publication: 057- 251 DSEE400 Configuration Software Manual.</b></p> <p>The module detected that an analogue input value had risen above the <i>Flexible Sensor High Alarm Trip</i> level.</p>
Flexible Sensor A to G Low	<p><b>▲ NOTE: Due to module configuration the alarm message that appears on the display may be different. For further details of module configuration, refer to DSE Publication: 057- 251 DSEE400 Configuration Software Manual.</b></p> <p>The module detected that an analogue input value had fallen below the <i>Flexible Sensor Low Alarm Trip</i> level.</p>
Fuel Level Low IEEE C37.2 - 71 Liquid Level Switch	The module detected that the engine fuel level had fallen below the <i>Low Fuel Level Trip</i> level.
Fuel Level Low Switch IEEE C37.2 - 71 Liquid Level Switch	The module detected that the engine low fuel level switch had activated.
Fuel Usage IEEE C37.2 - 80 Flow Switch	The module detected that the fuel consumption was more than the configured Running Rate or Stopped Rate.
Loss of Mag-PU	The module detected that the magnetic pick up was not producing a pulse output after the required Crank Disconnect criteria had been met.

Continued over page...

Fault	Description
Maintenance Due	<p><b>▲ NOTE: Due to module configuration the alarm message that appears on the display may be different. For further details of module configuration, refer to DSE Publication: 057- 251 DSEE400 Configuration Software Manual.</b></p> <p>The module detected that one of the configured maintenance alarms is due as its configured maintenance interval has expired.</p>
SCR Inducement	<p>The module received a fault condition from the engine ECU alerting about the SCR Inducement.</p>
Water in Fuel	<p>The module received a fault condition from the engine ECU alerting that water in the fuel had been detected.</p>

## 6.5 SHUTDOWN ALARMS

 **NOTE:** Shutdown and Controlled Shutdown alarms can be disabled by user configuration. See the section entitled *Protections Disabled* elsewhere in this document.

 **NOTE:** The fault condition must be resolved before the alarm can be reset. If the fault condition remains, it is not possible to reset the alarm (the exception to this is the *Oil Pressure Low* alarm and similar *Active From Safety On* alarms, as the oil pressure is low with the engine at rest).

Shutdown Alarms are latching and immediately stop the engine. On initiation of the shutdown condition the module de-activates the **Clutch Control Output** outputs to remove the load from the engine. Once this has occurred, the module shuts the engine down immediately to prevent further damage. To restart the engine the fault must be cleared, and the alarm reset.

**Example:**

1/2      Alarm
Oil Pressure Low
Shutdown

In the event of an alarm the LCD jumps to the alarms page and scrolls through all active alarms.

Shutdown Alarms are latching alarms and to remove the fault, press the **Stop/Reset Mode**  button on the module.

Fault	Description
Analogue Input A to G (Digital)	<div style="border: 1px solid black; padding: 5px; margin-bottom: 5px;">  <b>NOTE:</b> Due to module configuration the alarm message that appears on the display may be different. For further details of module configuration, refer to DSE Publication: <i>057- 251 DSEE400 Configuration Software Manual</i>.                 </div> <p>The module detected that an analogue input configured as a digital input to create a fault condition became active and the appropriate LCD message is displayed.</p>
Calibration Fault	The module detected that its internal calibration has failed. The unit must be sent back to DSE to be investigated and repaired. Contact DSE Technical Support for more details.
Charge Alt Failure <small>IEEE C37.2 – 27DC Undervoltage Relay</small>	The module detected that the output voltage of the charge alternator had risen above the <i>Charge Alternator Shutdown Trip</i> level for the configured delay timer.
Coolant Sender O/C	The module detected that circuit to the engine coolant temperature sensor had become open circuit.
Coolant Temp High <small>IEEE C37.2 – 26 Apparatus Thermal Device</small>	The module detected that the engine coolant temperature had risen above the <i>High Coolant Temperature Shutdown Trip</i> level after the <i>Safety On Delay</i> timer had expired.
Coolant Temp High Switch <small>IEEE C37.2 – 26 Apparatus Thermal Device</small>	The module detected that the high engine coolant temperature switch had activated after the <i>Safety On Delay</i> timer had expired.
DEF Level	The module received a fault condition from the engine ECU alerting about the DEF level.

Continued over page...

Fault	Description
Digital Input A to D	<p><b>▲ NOTE: Due to module configuration the alarm message that appears on the display may be different. For further details of module configuration, refer to DSE Publication: 057- 251 DSEE400 Configuration Software Manual.</b></p> <p>The module detected that a digital input configured to create a fault condition became active and the appropriate LCD message is displayed.</p>
DPTC Filter	The module received a fault condition from the engine ECU alerting that the DPF/DPTC had activated.
ECU Amber	The module received an amber fault condition from the engine ECU.
ECU Data Fail	The module is configured for CAN operation but has not detected data being sent from the engine's ECU.
ECU Malfunc.	The module received a malfunction fault condition from the engine ECU.
ECU Protect	The module received a protect fault condition from the engine ECU.
ECU Red	The module received a red fault condition from the engine ECU.
Emergency Stop IEEE C37.2 - 5 Stopping Device	The module detected that emergency stop button had been pressed removing a positive voltage supply from the emergency stop input terminal. This input is failsafe (normally closed to emergency stop) and immediately stops the engine when the signal is removed.
Engine Over Speed IEEE C37.2 - 12 Overspeed Device	The module detected that the engine speed had risen above the <i>Over Speed Alarm Trip</i> level for the configured delay timer.
Engine Over Speed Overshoot IEEE C37.2 - 12 Overspeed Device	The module detected that the engine speed had risen above the <i>Over Speed Overshoot Trip</i> during the configured <i>Overshoot Delay</i> timer whilst starting.
Engine Under Speed IEEE C37.2 - 14 Underspeed Device	The module detected that the engine speed had fallen below the <i>Under Speed Alarm Trip</i> level for the configured delay timer after the <i>Safety On Delay</i> timer had expired.
Failed to Start IEEE C37.2 - 48 Incomplete Sequence Relay	The module detected that the engine had failed to start as it did not meet the required Crank Disconnect criteria during the configured number of Crank Attempts.
Failed to Stop IEEE C37.2 - 48 Incomplete Sequence Relay	<p><b>▲ NOTE: <i>Fail to Stop</i> could indicate a faulty oil pressure sensor. If engine is at rest, check the oil pressure sensor wiring and configuration.</b></p> <p>The module detects a condition that indicates the engine is running when the DSE module has instructed it to stop.</p>
Flexible Sensor A to G Fault	<p><b>▲ NOTE: Due to module configuration the alarm message that appears on the display may be different. For further details of module configuration, refer to DSE Publication: 057- 251 DSEE400 Configuration Software Manual.</b></p> <p>The module detected that circuit to the flexible sensor had become open circuit.</p>

Continued over page...

Fault	Description
Flexible Sensor A to G High	<p><b>▲ NOTE: Due to module configuration the alarm message that appears on the display may be different. For further details of module configuration, refer to DSE Publication: 057- 251 DSEE400 Configuration Software Manual.</b></p> <p>The module detected that an analogue input value had risen above the <i>Flexible Sensor High Alarm Trip</i> level.</p>
Flexible Sensor A to G Low	<p><b>▲ NOTE: Due to module configuration the alarm message that appears on the display may be different. For further details of module configuration, refer to DSE Publication: 057- 251 DSEE400 Configuration Software Manual.</b></p> <p>The module detected that an analogue input value had fallen below the <i>Flexible Sensor Low Alarm Trip</i> level.</p>
Fuel Level Low IEEE C37.2 - 71 Liquid Level Switch	The module detected that the engine fuel level had fallen below the <i>Low Fuel Level Trip</i> level.
Fuel Level Low Switch IEEE C37.2 - 71 Liquid Level Switch	The module detected that the engine low fuel level switch had activated.
Fuel Usage IEEE C37.2 - 80 Flow Switch	The module detected that the fuel consumption was more than the configured Running Rate or Stopped Rate.
Loss of Mag-PU	The module detected that the magnetic pick up was not producing a pulse output after the required Crank Disconnect criteria had been met.
Mag-PU Fault	The module detected that circuit to the magnetic pick-up sensor had become open circuit.
Maintenance Due	<p><b>▲ NOTE: Due to module configuration the alarm message that appears on the display may be different. For further details of module configuration, refer to DSE Publication: 057- 251 DSEE400 Configuration Software Manual.</b></p> <p>The module detected that one of the configured maintenance alarms is due as its configured maintenance interval has expired.</p>
Oil Press Sender Fault	The module detected that circuit to the engine oil pressure sensor had become open circuit.
Oil Pressure Low IEEE C37.2 - 63 Pressure Switch	The module detected that the engine oil pressure had fallen below the <i>Low Oil Pressure Shutdown Trip</i> level after the <i>Safety On Delay</i> timer had expired.
Oil Pressure Low Switch IEEE C37.2 - 63 Pressure Switch	The module detected that the low oil pressure switch had activated after the <i>Safety On Delay</i> timer had expired.
SCR Inducement	The module received a fault condition from the engine ECU alerting about the SCR Inducement.
Water in Fuel	The module received a fault condition from the engine ECU alerting that water in the fuel had been detected.

## 6.6 MAINTENANCE ALARMS

Depending upon module configuration one or more levels of engine maintenance alarm may occur based upon a configurable schedule. Once configured, the maintenance alarms are available to adjust within the front panel editor.

When activated, the maintenance alarm can be either a *Warning* (set continues to run) or *Shutdown* (running the set is not possible).

Resetting the maintenance alarm is normally actioned by the site service engineer after performing the required maintenance.

The method of reset is either by:

- Activating an input that has been configured to Maintenance Reset Alarm 1, 2, 3, 4 or 5.
- Pressing the maintenance reset button in the DSE Configuration Suite, Maintenance section.
- Hold the stop button for 5 seconds when the alarm is displayed, and the module is configured for maintenance reset by front panel.

Screen capture from DSE Configuration Suite Software showing the configuration of a digital input for Reset Maintenance Alarm.

The screenshot displays the 'Maintenance Alarm' configuration window, which is divided into three sections for 'Maintenance Alarm 1', 'Maintenance Alarm 2', and 'Maintenance Alarm 3'. Each section contains the following fields:

- Enable:** A checked checkbox.
- Description:** A text box containing the alarm name (e.g., 'Maintenance Alarm 1').
- Action:** A dropdown menu set to 'Warning'.
- Engine run hours:** A numeric input set to '10' with 'hrs' as the unit.
- Enable alarm on due date:** A checked checkbox.
- Maintenance interval:** A numeric input set to '1' with 'months' as the unit.

The screenshot shows the 'Digital Input A' configuration window with the following settings:

- Function:** A dropdown menu set to 'Reset Maintenance Alarm 1'.
- Polarity:** A dropdown menu set to 'Close to Activate'.
- Action:** A dropdown menu.
- Arming:** A dropdown menu.
- LCD Display:** A text box containing 'Digital Input A'.
- Activation Delay:** A slider set to '0s'.

Screen capture from DSE Configuration Suite Software showing the Maintenance Alarm Reset 'button' in the DSE Configuration Suite PC Software SCADA | Maintenance section.

The screenshot shows the 'Maintenance Alarm Reset' window for 'Maintenance Alarm 1'. It displays the following information:

- Running Time Until Next Maintenance:** 10:00
- Date Of Next Maintenance:** 11/03/2000 15:57:46
- Reset:** A large yellow button.
- Instruction:** 'Press reset to schedule next maintenance, based upon module's maintenance configuration.'

## 7 FRONT PANEL CONFIGURATION

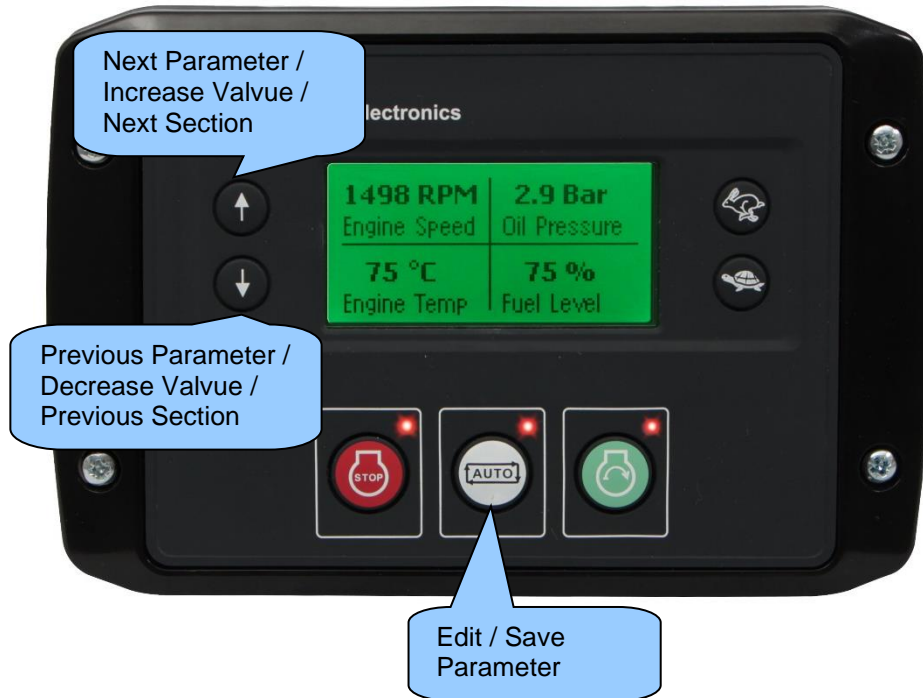

This configuration mode allows the operator to fully configure the module through its display without the use of the DSE Configuration Suite PC Software.

Use the module's facia buttons to traverse the menu and make value changes to the parameters:



## 7.1 ACCESSING THE FRONT PANEL CONFIGURATION EDITOR

**NOTE:** More comprehensive module configuration is possible via PC configuration software. For further details of module configuration, refer to DSE Publication: 057- 251 DSEE400 Configuration Software Manual.







- Ensure the engine is at rest and the module by pressing the **Stop/Reset Mode**  button.
- Press and hold the **Stop/Reset Mode**  and **Auto Mode**  buttons together to enter the front panel configuration editor.

### 7.1.1 ENTERING PIN









**NOTE:** The PIN is not set by DSE when the module leaves the factory. If the module has a PIN code set, the engine supplier has entered this. Contact the engine supplier if the code is required. If the code has been 'lost' or 'forgotten', the module must be returned to the DSE factory to have the PIN removed. A charge is made for this procedure. This procedure cannot be performed away from the DSE factory.

**NOTE:** The PIN is automatically reset after exiting the editor (manually or automatically) to ensure security.

**NOTE:** It is possible to configure the Module for differing *Read* and *Write* PIN codes. When accessing the FPE only the Read PIN is applicable.

- If a module security PIN has been set, the PIN request is then shown.
- Press the **Auto Mode**  button, the first '#' changes to '0'. Press the **Up**  or **Down**  buttons to adjust it to the correct value.
- Press and hold the **Up**  button when the first digit is correctly entered. The digit previously entered now shows as '#' for security.
- Repeat this process for the other digits of the PIN number. Press and hold the **Down**  button to adjust one of the previous digits. Press the **Auto Mode**  button to finish editing the PIN
- Press the **Auto Mode**  button to check the PIN for validity. If the number is not correct, the PIN must be re-entered.
- If the PIN has been successfully entered (or the module PIN has not been enabled), the editor is displayed.

### 7.1.2 EDITING A PARAMETER

- Press and hold the **Up**  or **Down**  buttons to cycle to the section to view/change.
- Press the **Up**  or **Down**  buttons to select the parameter to view/change within the currently selected section.
- To edit the parameter, press the **Auto Mode**  button to enter edit mode. The parameter begins to flash to indicate editing.
- Press the **Up**  or **Down**  buttons to change the parameter to the required value.
- Press the **Auto Mode**  to save the value. The parameter ceases flashing to indicate that it has been saved.











### 7.1.3 EDITING A PLC INSTRUMENT PARAMETER

 **NOTE:** PLC Instrument page is only available on hardware version E400-002-## or above. As per E400 v6 only PLC watched timers, counters and persistent variables may be edited.

#### Counter Example:

PLC Instruments	
New Counter 1	5

**Counter 1:** The name of the Counter as configured in the PLC.

- **Value:** The value the Counter currently contains. This value can be edited from the fascia by pressing and holding the **Stop/Reset Mode**  and **Auto Mode**  buttons together to enter the front panel configuration editor.
- Press the **Up**  or **Down**  buttons to select *Editor – PLC*.
- Use the **Up**  or **Down**  buttons to select the parameter.
- To edit the parameter, press the **Auto Mode**  button to enter edit mode. The parameter begins to flash to indicate editing.
- Press the **Up**  or **Down**  buttons to change the parameter to the required value.
- Press the **Auto Mode**  to save the value. The parameter ceases flashing to indicate that it has been saved.

#### 7.1.4 EXITING THE MAIN CONFIGURATION EDITOR

 **NOTE: The editor automatically exits after 5 minutes of inactivity to ensure security.**

- Press and hold the **Stop/Reset Mode**  button to exit the editor without saving changes.

 **NOTE: Pressing and holding the Stop/Reset Mode button to exit the editor will still save changes to the LCD Contrast, Backlight Level, Language, and Current Date and Time.**

- Press and hold the **Auto Mode**  button to exit the editor and save the changes.

### 7.1.5 ADJUSTABLE PARAMETERS

The following tables contain all the pages available in the FPE, each item is only adjustable when associated functions are enabled. Where an alarm is adjusted, both the trip and return value will be moved by the same amount. Where an alarm value must not be allowed past another value, the adjustment will not be allowed to continue any further in that direction. If an editor item contains a list, the contents in the list may change according to other module settings.

Section	Parameter As Shown On Display	Default Value
<b>Display</b>	Contrast	66 %
	Backlight Level	100 %
	Language	English
	Current Date and Time	Day:month:year, hour:minute:seconds
<b>Engine</b>	Oil Pressure Low Shutdown (When Enabled)	1.03 bar, kPa, psi
	Oil Pressure Low Pre Alarm (When Enabled)	1.24 bar, kPa, psi
	Coolant Temperature High Pre Alarm (When Enabled)	90 °C, °F
	Coolant Temp High Controlled Shutdown (When Enabled)	92 °C, °F
	Coolant Temperature High Shutdown (When Enabled)	95 °C, °F
	Pre Heat Temperature (When Enabled)	50 °C, °F
	Pre Heat Timer	0 h 0 m 0 s
	Post Heat Temperature (When Enabled)	50 °C, °F
	Post Heat Timer	0 h 0 m 0 s
	Under Speed Shutdown	Active, Inactive
	Under Speed Shutdown	1200 rpm
	Under Speed Warning	Active, Inactive
	Under Speed Warning	1260 rpm
	Over Speed Warning	Active, Inactive
	Over Speed Warning	1650 rpm
	Over Speed Shutdown	1710 rpm
	Overspeed Overshoot	0s
	Overspeed Overshoot	0%
	Battery Under Voltage Warning	Active, Inactive
	Battery Under Voltage Warning	10.0v
	Battery Under Voltage Warning Delay	0h 1m 0s
	Battery Over Voltage Warning	Active, Inactive
	Battery Over Voltage Warning	30.0v
	Battery Over Volts Warning Delay	0h 1m 0s
	Charge Alternator Failure Pre-Alarm	Active, Inactive
	Charge Alternator Failure Pre-Alarm	6.0v
	Charge Alternator Failure Pre-Alarm Delay	0h 0m 5s
	Charge Alternator Failure Shutdown	Active, Inactive
	Charge Alternator Failure Shutdown	4.0v
	Charge Alternator Shutdown Delay	0h 0m 5s
<b>Speed Settings</b>	Cranking Speed	0 rpm
	Warming Speed	0 rpm
	Idle Speed	0 rpm
	Priming Speed	0 rpm
	DPF Regeneration Speed	Active, Inactive (* Note.1)
	DPF Regeneration Speed	0 rpm (* Note.2)
	Cooldown Speed	0 rpm





Continued over page...

Commissioning









Section	Parameter As Shown On Display	Default Value
<b>Speed Control</b>	Min Speed	0 rpm
	Default Running Speed	0 rpm
	Max Speed	0 rpm
	Fixed Running Speed	0 rpm
	Selectable Speed 1	0 rpm
	Selectable Speed 2	0 rpm
	Selectable Speed 3	0 rpm
	Selectable Speed 4	0 rpm
	Linear Min Sensor Value	[Value] <user / preset defined units>
	Linear Max Sensor Value	[Value] <user / preset defined units>
	Linear Speed at Min	0 rpm
	Linear Speed at Max	0 rpm
	Emptying Speed	0 rpm
	Filling Speed	0 rpm
	Maintain Empty Running Speed	0 rpm
	Maintain Empty Emptying Speed	0 rpm
	Maintain Empty Setpoint	[Value] <user / preset defined units>
	Maintain Empty Deadband	[Value] <user / preset defined units>
	Maintain Fill Running Speed	0 rpm
	Maintain Fill Filling Speed	0 rpm
	Maintain Fill Setpoint	[Value] <user / preset defined units>
	Maintain Fill Deadband	[Value] <user / preset defined units>
	Engine Start Value	[Value] <user / preset defined units>
	Engine Stop Value	[Value] <user / preset defined units>
<b>Clutch Control</b>	Clutch Disengage Low Speed	0 rpm
	Clutch Engage Speed	0 rpm
	Clutch Disengage High Speed	8000 rpm
	Clutch Re-Engage	0 rpm
<b>CAN</b>	CAN Terminator Active	Active, Inactive
	DPF Auto Regen Inhibit	Active, Inactive
	DPF Manual Regen	Active, Inactive
	DPF Manual Regen Cancel	Active, Inactive
<b>Maintenance</b>	Maintenance PIN protect	Active, Inactive
	Maintenance Alarm 1	10h
	Maintenance Alarm 2	10h
	Maintenance Alarm 3	10h
	Maintenance Alarm 4	10h
	Maintenance Alarm 5	10h
	Maintenance Alarm 6	10h
	Maintenance Alarm 7	10h
	Maintenance Alarm 8	10h
	Maintenance Alarm 9	10h
	Maintenance Alarm 10	10h
<b>Flexible Sensors</b>	Flexible Sensor (A-G) Low Alarm	Active, Inactive
	Flexible Sensor (A-G) Low Alarm	[value] <unit description>
	Flexible Sensor (A-G) Low Pre-Alarm	Active/Inactive
	Flexible Sensor (A-G) Low Pre-Alarm	[value] <unit description>
	Flexible Sensor (A-G) High Pre-Alarm	Active/Inactive
	Flexible Sensor (A-G) High Pre-Alarm	[value] <unit description>
	Flexible Sensor (A-G) High Alarm	Active/Inactive
	Flexible Sensor (A-G) High Alarm	[value] <unit description>
<b>PLC Instruments</b>	PLC Watched Item (1-16)	[PLC value] <PLC units>

Continued over page...

Protections

Section	Parameter As Shown On Display	Default Value
<b>Timers</b>	LCD Page Timer	0h 5m 0s
	LCD Scroll Delay	0h 0m 2s
	Start Delay Off load	5s
	Start Delay On load	5s
	Start Delay Telemetry	5s
	Delayed Engine Start	0h 0m 30s
	Cranking	0m 10s
	Cranking Rest	0m 10s
	Safety On Delay	0m 10s
	Smoke Limiting	0h 0s
	Smoke Limiting Off	0h 0s
	Warming	0h 0m 0s
	Return Delay	0h 0m 30s
	Cooling	0h 1m 0s
	Cooling at Idle	0h 1m 0s
	Failed To Stop Delay	0m 30s
	Delayed Engine Stop	0h 0m 30s
	Engine Speed Transient Delay	0.0s
	Priming Delay	0h 0m 30s
	Selectable Speed Transfer Delay	0m 0.2s
	DPF Ramp	5s
	Run Time Enable	Active, Inactive
	Run Time	0h 15m 0s
<b>Scheduler</b>	Schedule	Active, Inactive
	Schedule Period	Weekly/Monthly (Only Available When Scheduler Is Active)
	Schedule Time & Date Selection (1-8)	Press the <b>Auto Mode</b>  button to begin editing. Press and hold the <b>Up</b>  or <b>Down</b>  buttons to select the different parameters in the scheduler. Press the <b>Up</b>  or <b>Down</b>  buttons to change the value of the parameter.
	1 Schedule	Off Load / On Load / Auto start inhibit
	Week 1 (If Monthly selected)	Week1, Week2, Week3, Week4
	On	00:00
	Run Time	00:00
	M T W T F S S	Select day of the week
<b>Active Configuration</b>	Active Config Select	<Main Configuration> /
		<Alternative Config 1> /
		<Alternative Config 2> /
		<Alternative Config 3> /
		<Alternative Config 4> /

### 7.1.6 EDITING A PARAMETER

- Press and hold the **Up**  or **Down**  buttons to cycle to the section to view/change.
- Press the **Up**  or **Down**  buttons to select the parameter to view/change within the currently selected section.
- To edit the parameter, press the **Auto Mode**  button to enter edit mode. The parameter begins to flash to indicate editing.
- Press the **Up**  or **Down**  buttons to change the parameter to the required value.
- Press the **Auto Mode**  to save the value. The parameter ceases flashing to indicate that it has been saved.

## 8 COMMISSIONING

 **NOTE: If Emergency Stop feature is not required, link the input to the DC Positive.**

Before the system is started, it is recommended that the following checks are made:

The unit is adequately cooled and all the wiring to the module is of a standard and rating compatible with the system. Check all mechanical parts are fitted correctly and that all electrical connections (including earths) are sound.

The unit DC supply is fused and connected to the battery and that it is of the correct polarity.

The Emergency Stop input is wired to an external normally closed switch connected to DC positive.

To check the start cycle operation, take appropriate measures to prevent the engine from starting (disable the operation of the fuel solenoid). After a visual inspection to ensure it is safe to proceed, connect the battery supply. Press the **Manual/Start Mode**  button, the unit start sequence commences.

The starter engages and operates for the pre-set crank period. After the starter motor has attempted to start the engine for the pre-set number of attempts, the LCD displays *Failed to Start*. Press the **Stop/Reset Mode**  button to reset the unit.

Restore the engine to operational status (reconnect the fuel solenoid). Press the **Manual/Start Mode**  button. This time the engine should start, and the starter motor should disengage automatically. If not then check that the engine is fully operational (fuel available, etc.) and that the fuel solenoid is operating. The engine should now run up to operating speed. If not, and an alarm is present, check the alarm condition for validity, then check input wiring. The engine should continue to run for an indefinite period. It is possible currently to view the engine parameters, refer to section 4 *Description of Controls*.

Press the **Auto Mode**  button, the engine runs for the pre-set cooling down period, then stop. The engine should stay in the standby mode. If it does not, check that the *Remote Start* input is not active.

Initiate an automatic start by supplying the remote start signal (if configured). The start sequence commences, and the engine runs up to operational speed. Once the engine is available the *Clutch Control Output* activates. If not, check the wiring to the clutch control mechanism. Check the Warming timer has timed out.

Remove the remote start signal. The return sequence begins. After the pre-set time, the engine is unloaded. The engine then runs for the pre-set cooling down period, then shutdown into its standby mode.

Set the modules internal clock/calendar to ensure correct operation of the scheduler and event logging functions. For details of this procedure see the section entitled *Front Panel Configuration* elsewhere in this document..

If, despite repeated checking of the connections between the controller and the customer's system, satisfactory operation cannot be achieved, then contact DSE Technical Support Department:

**Tel:** +44 (0) 1723 890099  
**E-mail:** [support@deepseaelectronics.com](mailto:support@deepseaelectronics.com)  
**Website:** [www.deepseaelectronics.com](http://www.deepseaelectronics.com)

## 9 FAULT FINDING

 **NOTE:** The below fault finding is provided as a guide checklist only. As the module can be configured to provide a wide range of different features, always refer to the source of the module configuration if in doubt.

### 9.1 STARTING

Symptom	Possible Remedy
Unit is inoperative  Read/Write configuration does not operate	Check the battery and wiring to the unit. Check the DC supply. Check the DC fuse.
Unit shuts down	Check DC supply voltage is not above 35 V or below 9 V Check the operating temperature is not above 80°C. Check the DC fuse.
Fail to Start is activated after pre-set number of attempts to start	Check wiring of fuel solenoid. Check fuel. Check battery supply. Check battery supply is present on the Fuel output of the module. Check the speed-sensing signal is present on the module's inputs. Refer to engine manual.
Continuous starting of engine when in the <b>Auto Mode</b> 	Check that there is no signal present on the "Remote Start" input. Check configured polarity is correct.
Engine fails to start on receipt of Remote Start signal.	Check Start Delay timer has timed out.  Check signal is on "Remote Start" input. Confirm correct configuration of input is configured to be used as "Remote Start".  Check that the oil pressure switch or sensor is indicating low oil pressure to the controller. Depending upon configuration, the set does not start if oil pressure is not low.
Pre-heat inoperative	Check wiring to engine heater plugs. Check battery supply. Check battery supply is present on the Pre-heat output of module. Check pre-heat configuration is correct.
Starter motor inoperative	Check wiring to starter solenoid. Check battery supply. Check battery supply is present on the Starter output of module. Ensure oil pressure switch or sensor is indicating the "low oil pressure" state to the controller.

### 9.2 LOADING

Symptom	Possible Remedy
Engine runs but does not take load	Check Warm up timer has timed out. Check connections to the clutch control mechanism.
Incorrect reading on Engine gauges	Check engine is operating correctly.
Fail to stop alarm when engine is at rest	Check that sensor is compatible with the module and that the module configuration is suited to the sensor.

### 9.3 ALARMS

Symptom	Possible Remedy
Oil pressure low fault operates after engine has fired	Check engine oil pressure. Check oil pressure switch/sensor and wiring. Check configured polarity (if applicable) is correct (i.e. Normally Open or Normally Closed) or that sensor is compatible with the module and is correctly configured.
Coolant temp high fault operates after engine has fired.	Check engine temperature. Check switch/sensor and wiring. Check configured polarity (if applicable) is correct (i.e. Normally Open or Normally Closed) or that sensor is compatible with the module.
Shutdown fault operates	Check relevant switch and wiring of fault indicated on LCD display. Check configuration of input.
Controlled Shutdown fault operates	Check relevant switch and wiring of fault indicated on LCD display. Check configuration of input.
Warning fault operates	Check relevant switch and wiring of fault indicated on LCD display. Check configuration of input.
ECU Amber ECU Red	This indicates a fault condition detected by the engine ECU and transmitted to the DSE controller.
ECU Data Fail	Indicates failure of the CAN data link to the engine ECU. Check all wiring and termination resistors (if required).
Incorrect reading on Engine gauges	Check engine is operating correctly. Check sensor and wiring paying particular attention to the wiring to terminals A11 and C4.
Fail to stop alarm when engine is at rest	Check that sensor is compatible with the module and that the module configuration is suited to the sensor.

### 9.4 COMMUNICATIONS

Symptom	Possible Remedy
ECU Data Fail	Indicates failure of the CAN data link to the engine ECU. Check all wiring and termination resistors (if required).

### 9.5 MISCELLANEOUS

Symptom	Possible Remedy
Module appears to 'revert' to an earlier configuration	<p>When editing a configuration using the PC software it is vital that the configuration is first 'read' from the controller before editing it. This edited configuration must then be "written" back to the controller for the changes to take effect.</p> <p>When editing a configuration using the fascia editor, be sure to press the <b>Auto Mode</b>  button to save the change before moving to another item or exiting the fascia editor</p>

## 10 MAINTENANCE, SPARES, REPAIR AND SERVICING

The controller is *Fit and Forget*. As such, there are no user serviceable parts within the controller. In the case of malfunction, you should contact your original equipment manufacturer (OEM).

If you require additional plugs from DSE, please contact our Sales department using the part numbers below.

### 10.1 CONNECTOR A FROM DSE

Item	Description	DSE Part No.
	Deutsche DT16-18SA-K004 Connector and Pins	007-850

### 10.2 CONNECTOR C FROM DSE

Item	Description	DSE Part No.
	Deutsche DT16-18SC-K004 Connector and Pins	007-851

### 10.3 WIRING HARNESS WITH CONNECTOR A & C FROM DSE

Item	Description	DSE Part No.
	1.2 m Wiring Harness Complete With Connector A & C.	007-852

### 10.4 REPLACEMENT USB SEALING BUNG FROM DSE

Item	Description	DSE Part No.
	USB Sealing Bung	007-031

### 10.5 REPLACEMENT PANEL SEALING GASKET FROM DSE

Item	Description	DSE Part No.
	Panel Sealing Gasket	007-545

### 10.6 USB CONFIGURATION CABLE FROM DSE

Item	Description	DSE Part No.
	PC Configuration interface lead (USB type A – USB type B)	016-125

## 11 WARRANTY

DSE Provides limited warranty to the equipment purchaser at the point of sale. For full details of any applicable warranty, refer to the original equipment supplier (OEM)

## 12 DISPOSAL

### 12.1 WEEE (WASTE ELECTRICAL AND ELECTRONIC EQUIPMENT)

If you use electrical and electronic equipment you must store, collect, treat, recycle and dispose of WEEE separately from your other waste.



*This Page is Intentionally Blank*

*This Page is Intentionally Blank*